

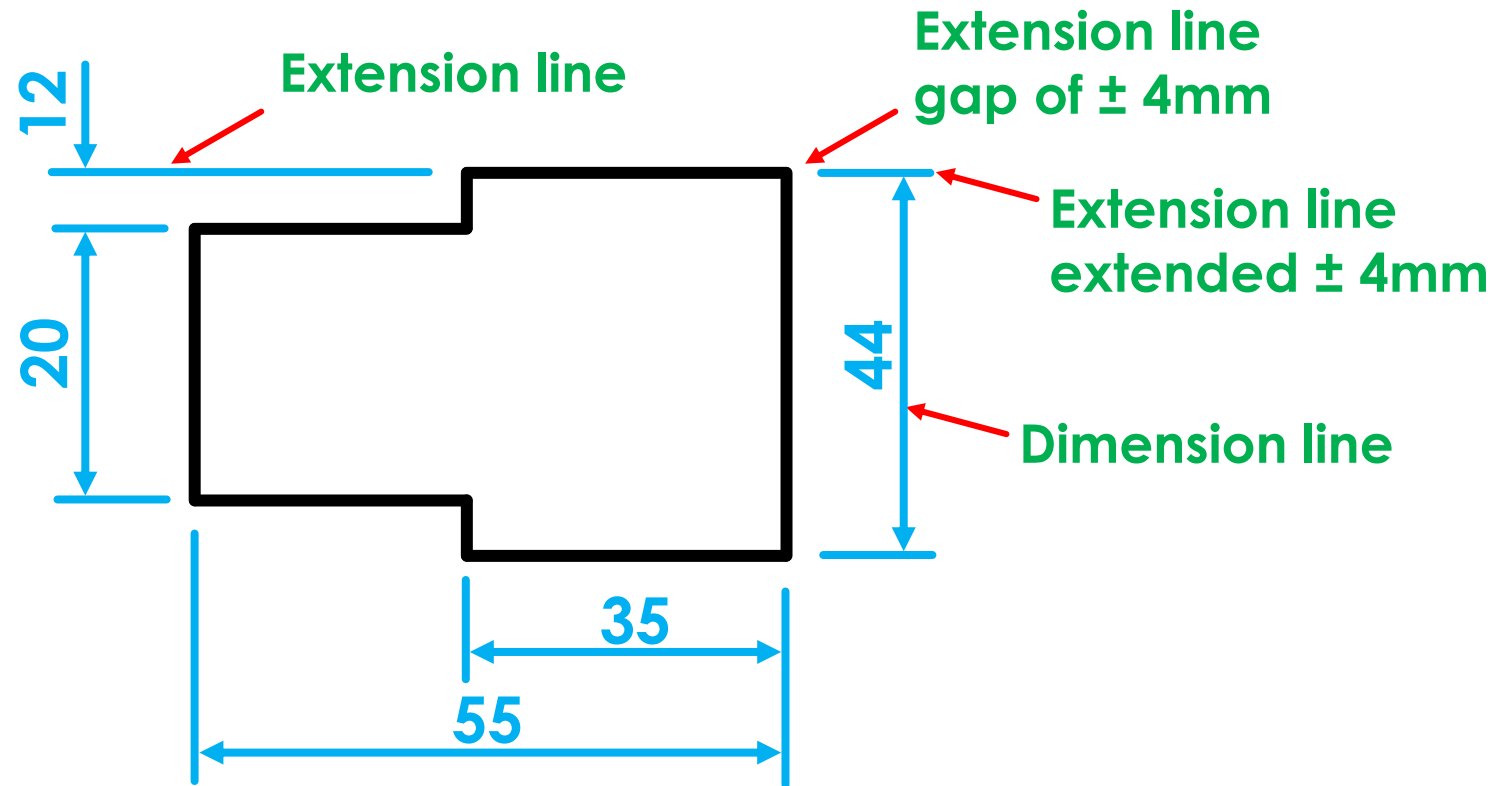

# Principles of Mechanical Drawings – DIMENSIONING

Developed by: PC Viljoen  
Senior Educational Specialist for  
Engineering Graphics and Design  
Free State Province

# Mechanical Drawings (dimensions)



# Mechanical Drawings (dimensions)

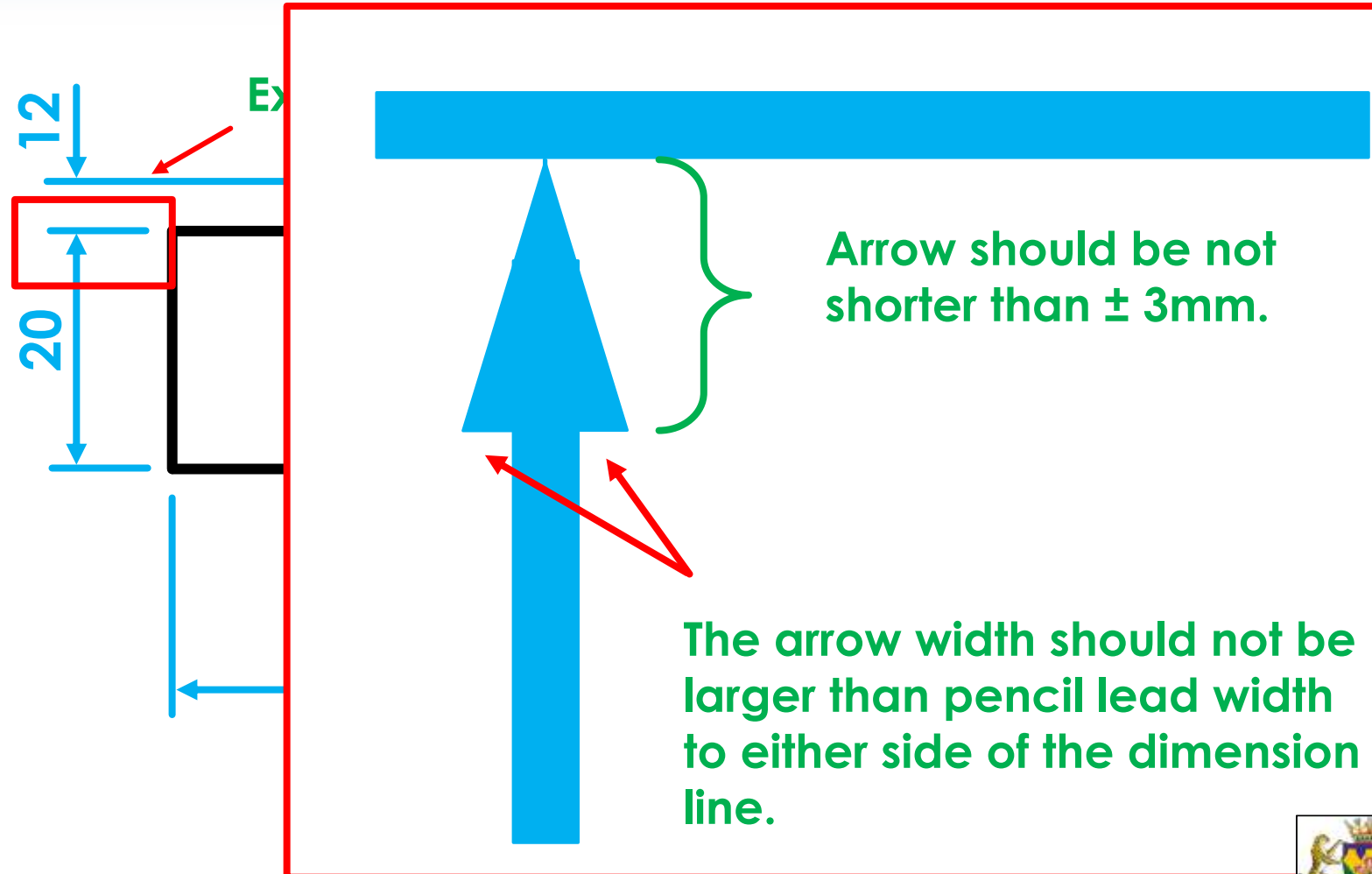

# Mechanical Drawings (dimensions)

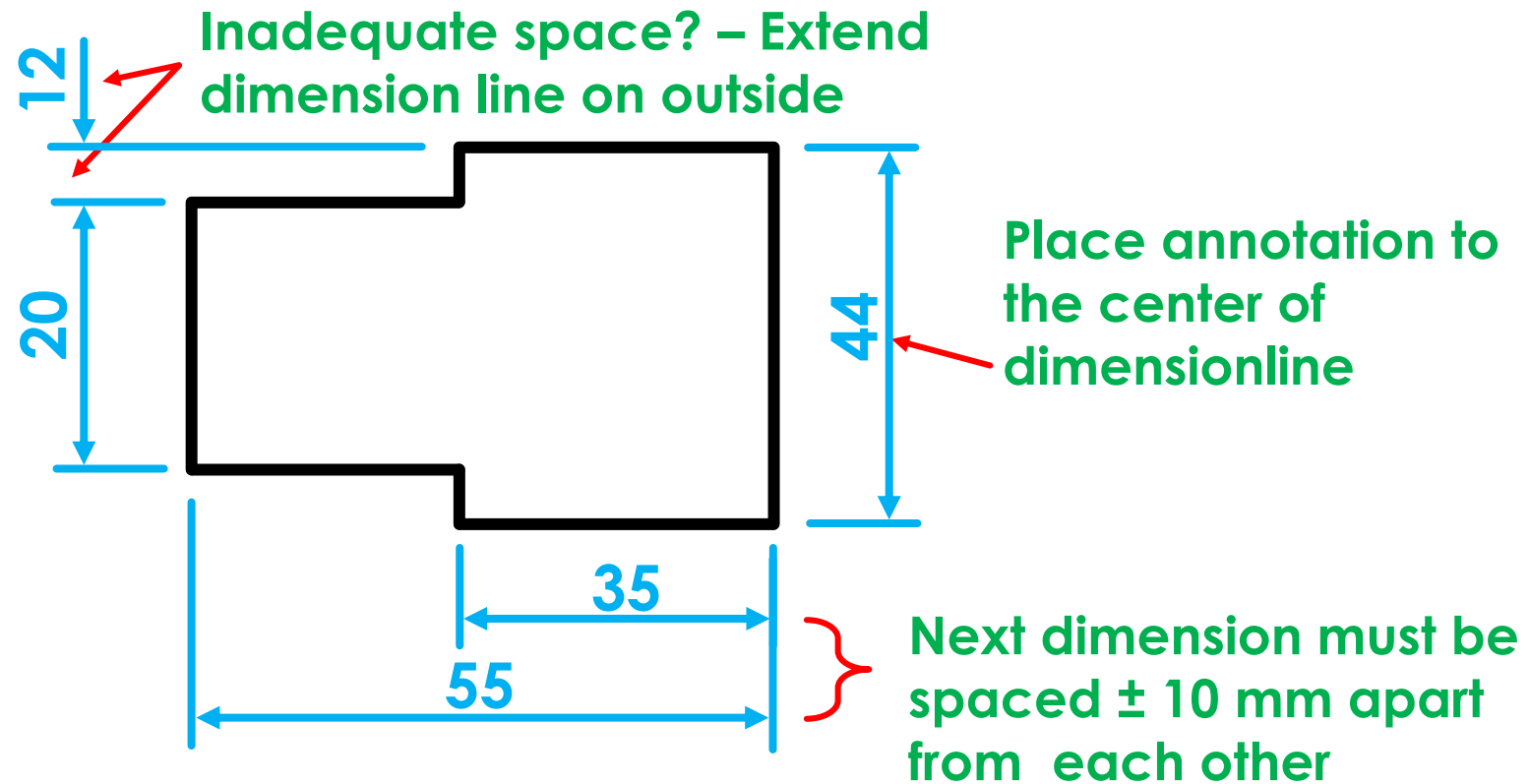

# Mechanical Drawings (dimensions)

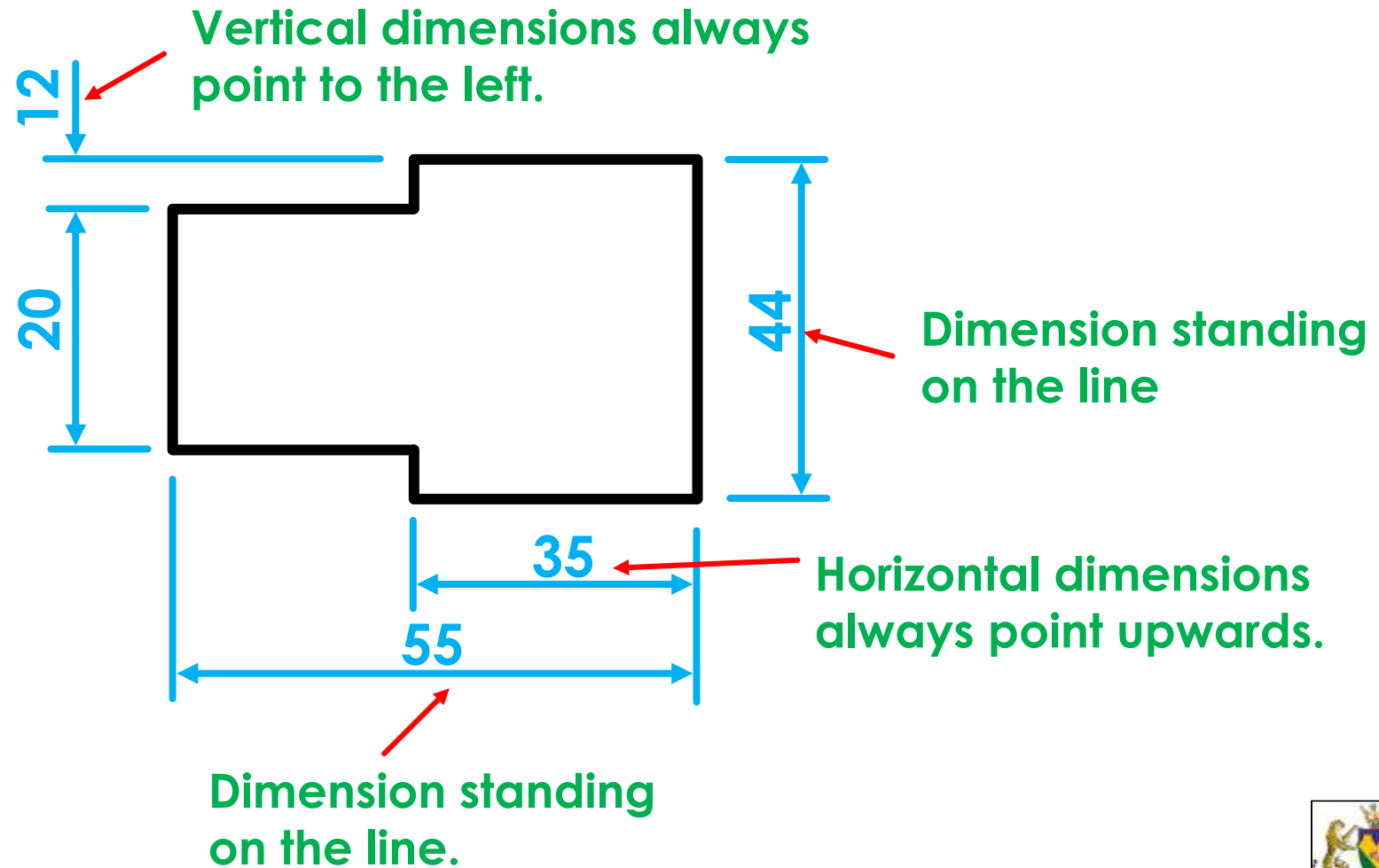

# Mechanical Drawings (dimensions)

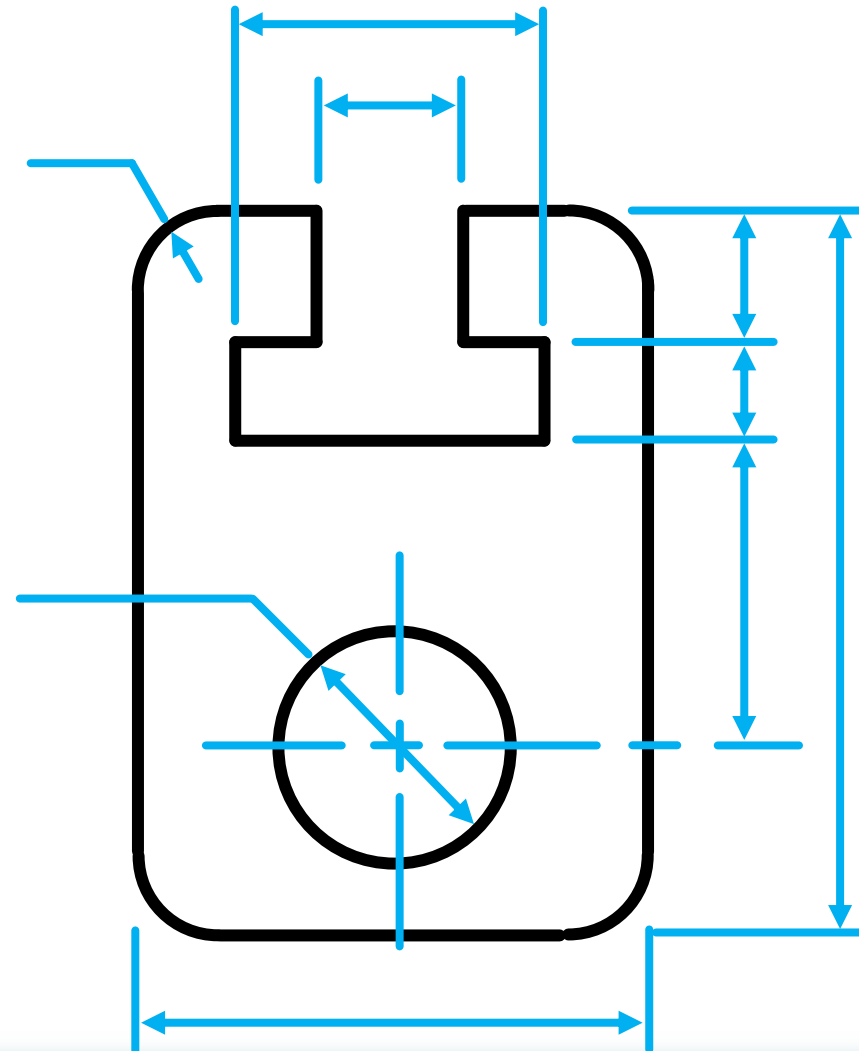

Dimension line placement should always be outside the drawing

# Mechanical Drawings (dimensions)

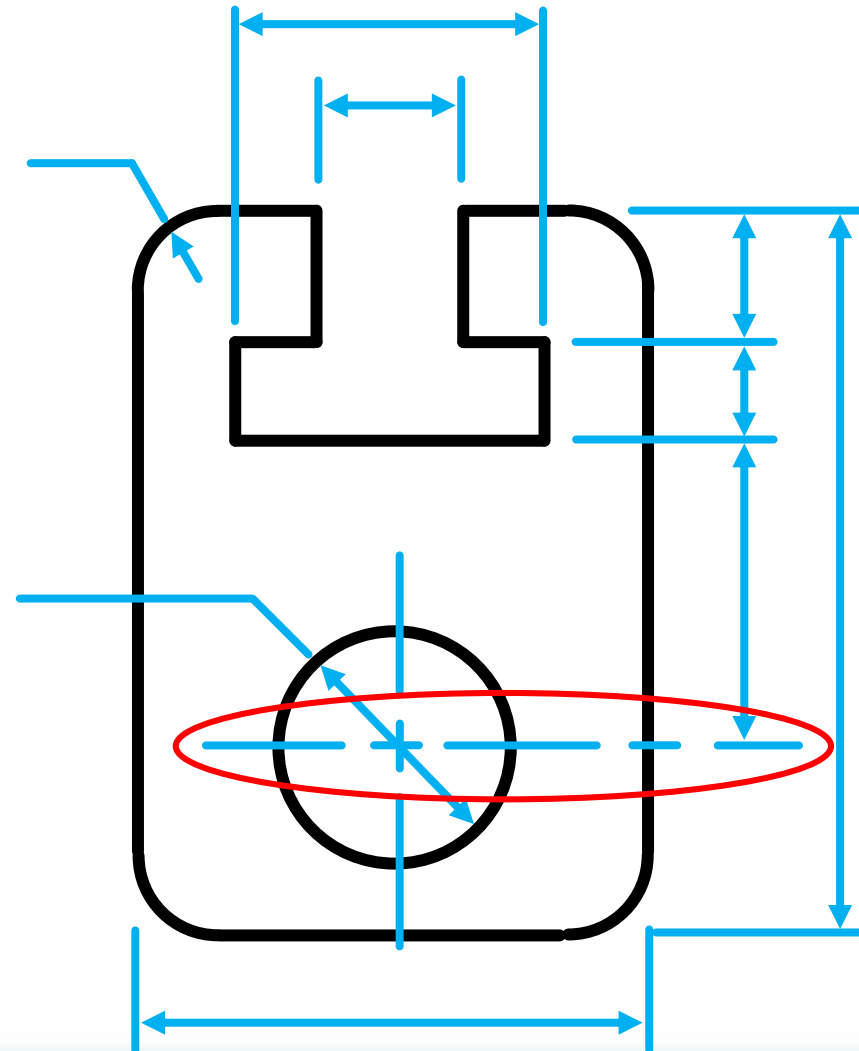

Centre lines may also be used as extension lines

# Mechanical Drawings (dimensions)

Positional  
dimensions

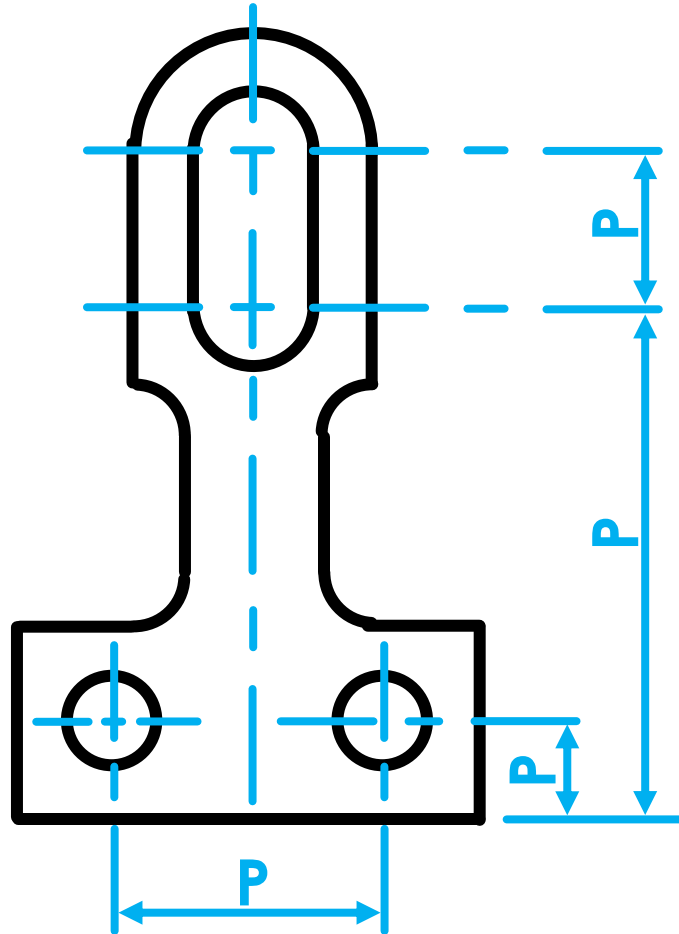

# Mechanical Drawings (dimensions)

Size  
dimensions

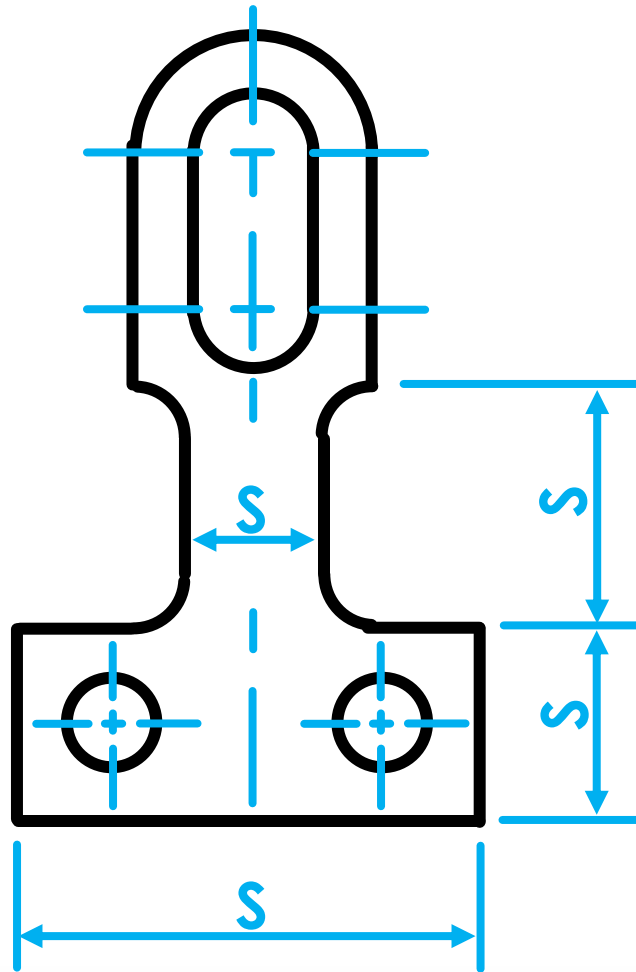

# Mechanical Drawings (dimensions)

- Radii dimensions of fillets.

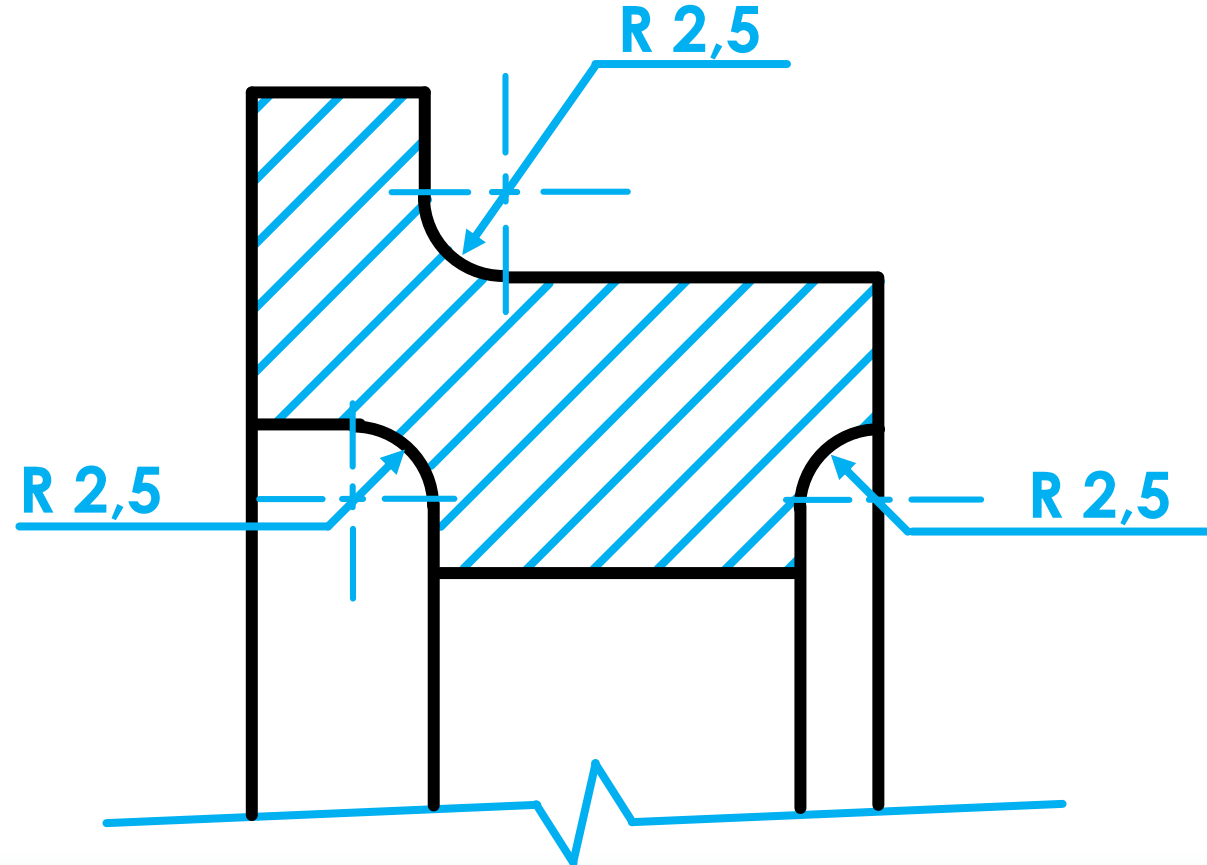

# Mechanical Drawings (dimensions)

- ▶ The largest dimension should be placed outside.

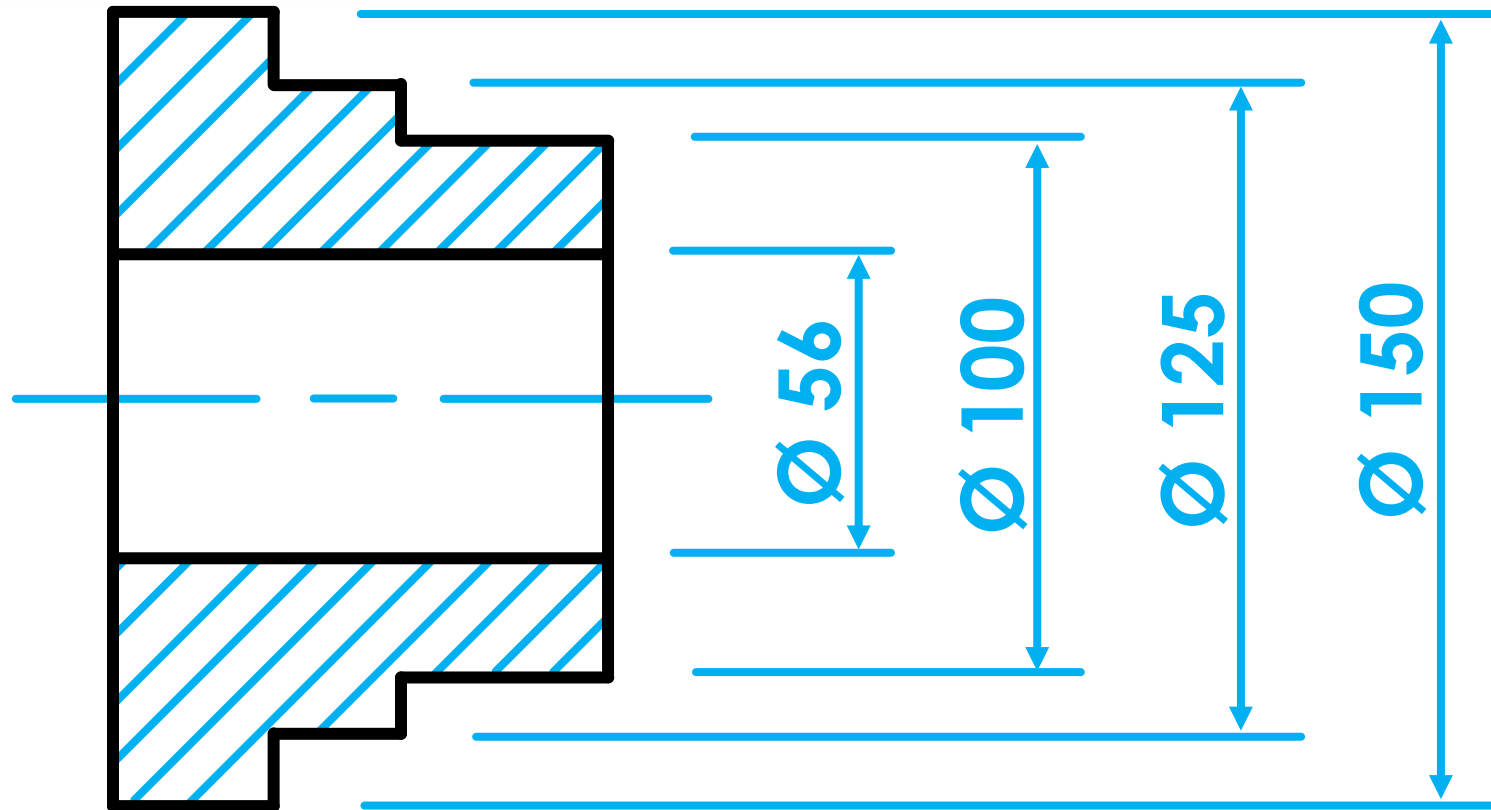

# Mechanical Drawings (dimensions)

- Overall dimensions should be placed outside intermediate dimensions

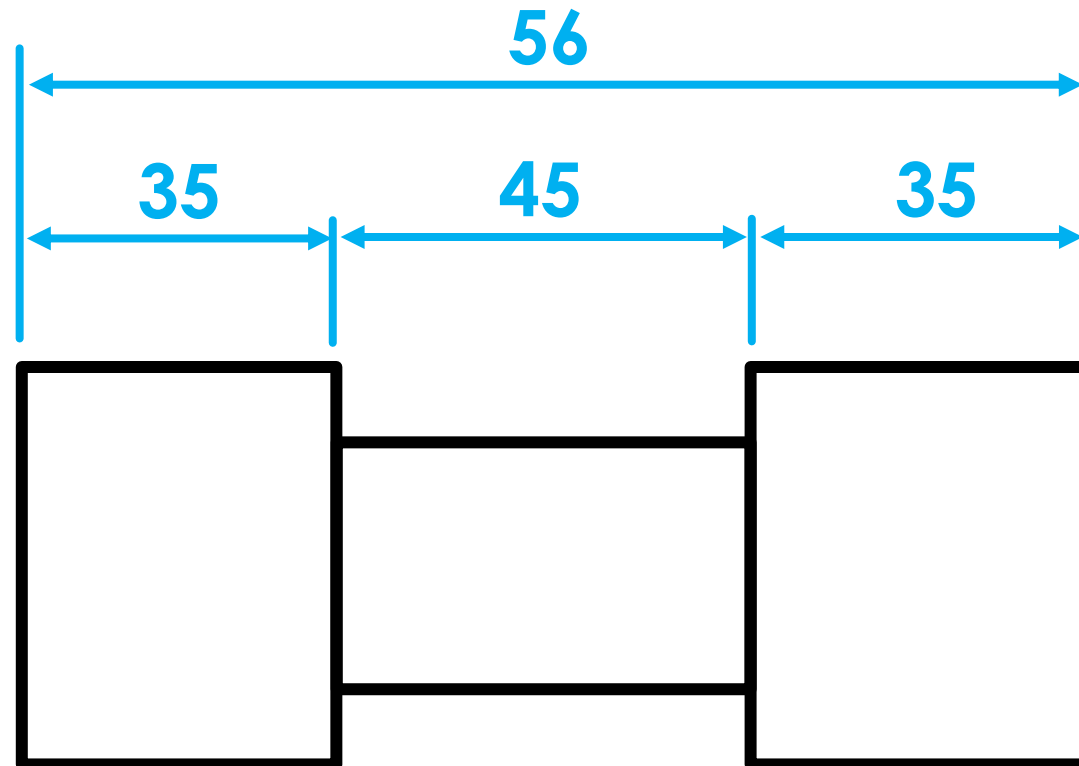

# Mechanical Drawings (dimensions)

- ▶ The leader should always be in line with the centre.

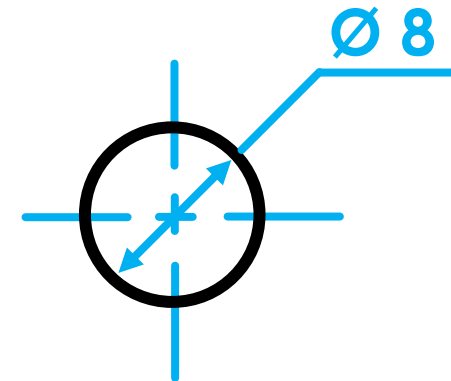
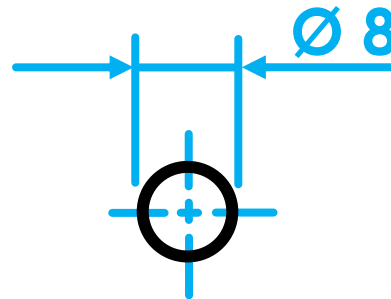
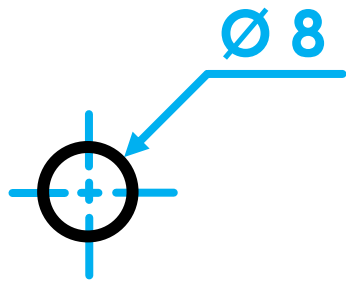

# Mechanical Drawings (dimensions)

- The leader should always be in line with the centre.

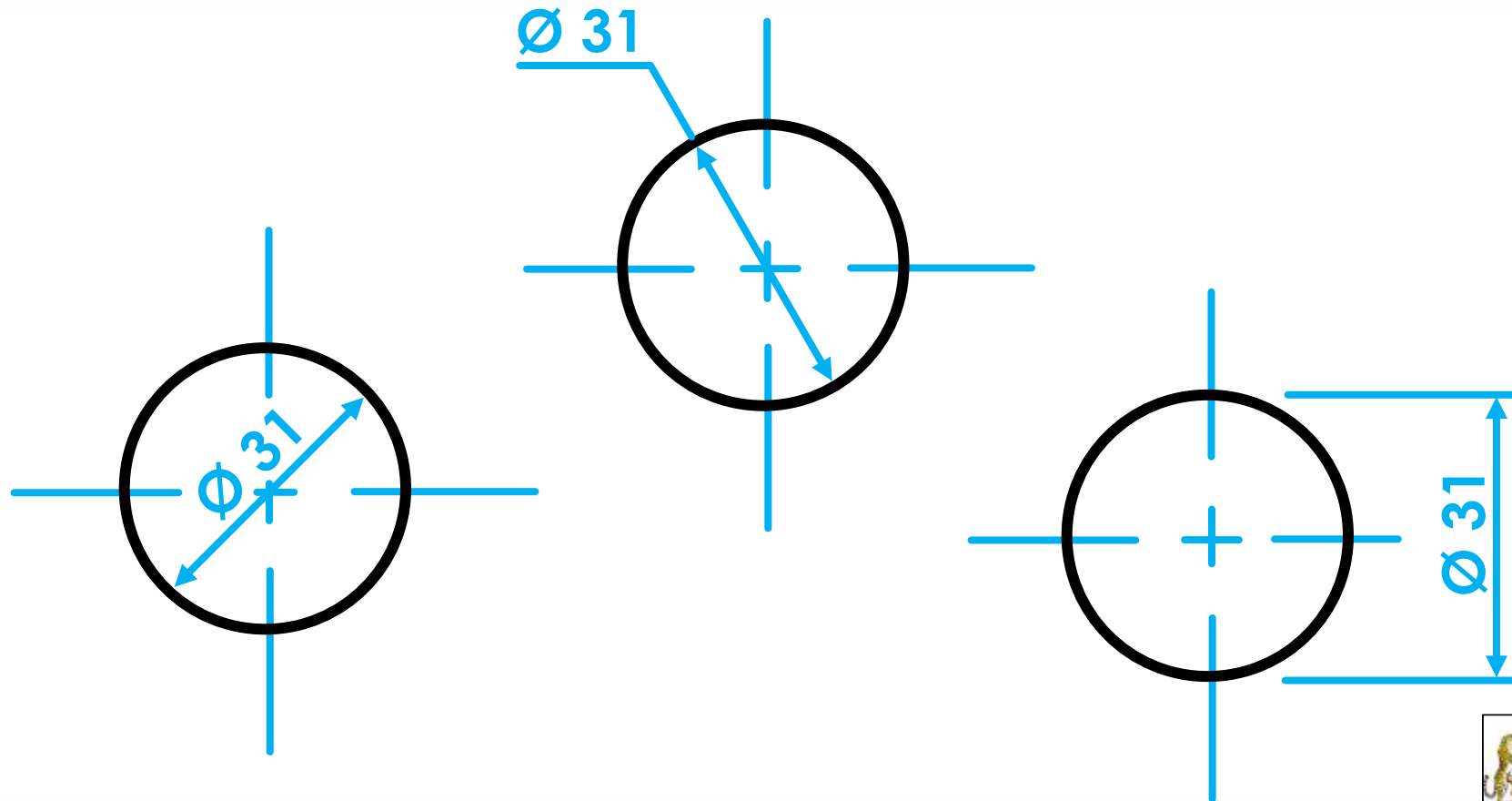

# Mechanical Drawings (dimensions)

- Indication of a sphere.

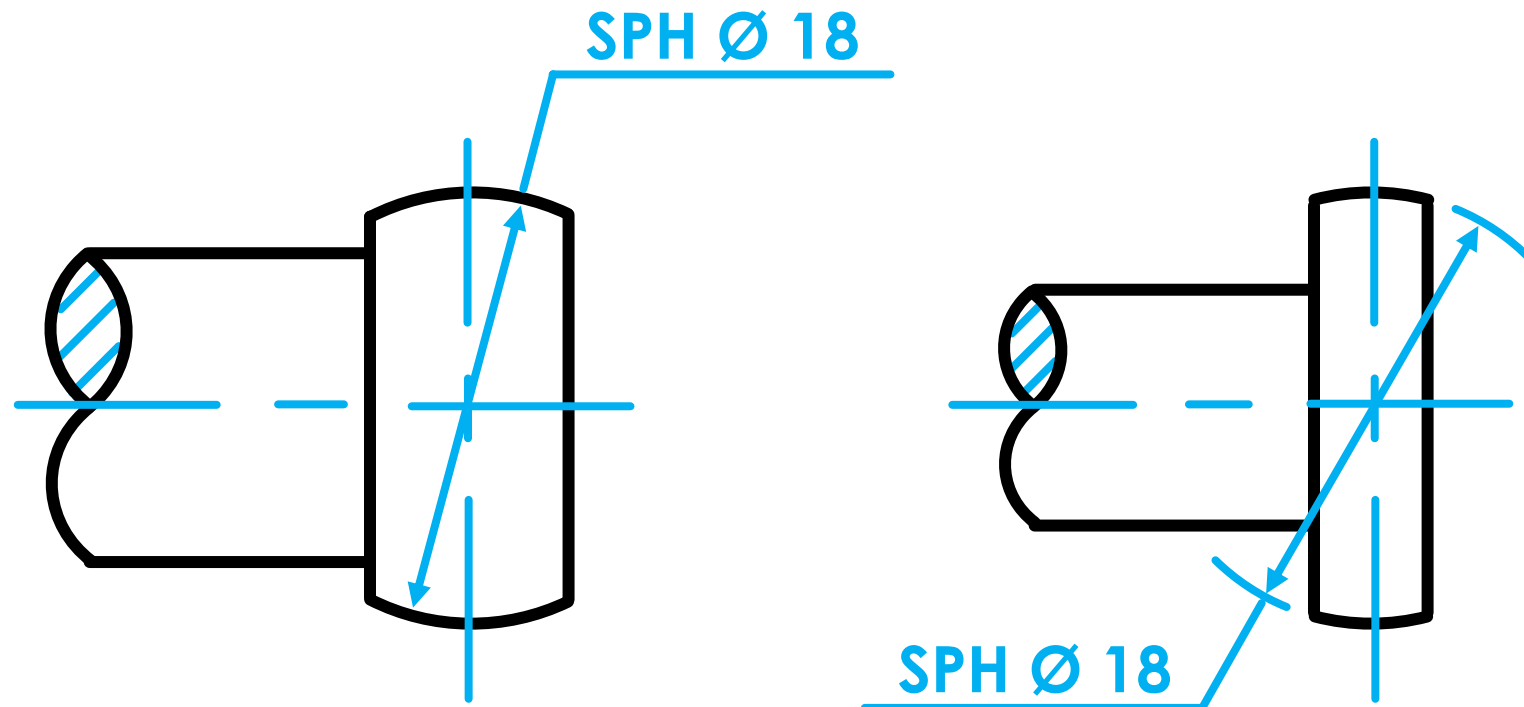

# Mechanical Drawings (dimensions)

- Dimensions not to scale
- Where any part of a view is not drawn to the given scale, the note "Dimensions are not to scale" should be added, or "NTS" printed after the relevant dimensions, or the dimensions should be underlined

# Mechanical Drawings (dimensions)

- Dimensions not to scale

