

THE CONSTRUCTION INDUSTRY CIVIL DRAWINGS

Developed by: PC Viljoen
Senior Educational Specialist for
Engineering Graphics and Design
Free State Province

GENERAL INFORMATION

- Electrical distribution symbol keys showing the following:
 - Ceiling mounted light fittings.
 - Waterproof wall mounted lights.
 - 15A plugs.
 - Geyser point.
 - Stove.
 - Distribution box

ELECTRICAL

- On the floor plan the position of the following components must be shown.
 - (main board),
 - distribution board,
 - lights,
 - plugs and
 - switches.

DISTRIBUTION BOARD

- ▶ This board houses all ...
 - ▶ Trip switches for the various circuits
 - ▶ The earth leakage relay or unit
 - ▶ Timers
 - ▶ Electrical meters.

DISTRIBUTION BOARD

DB

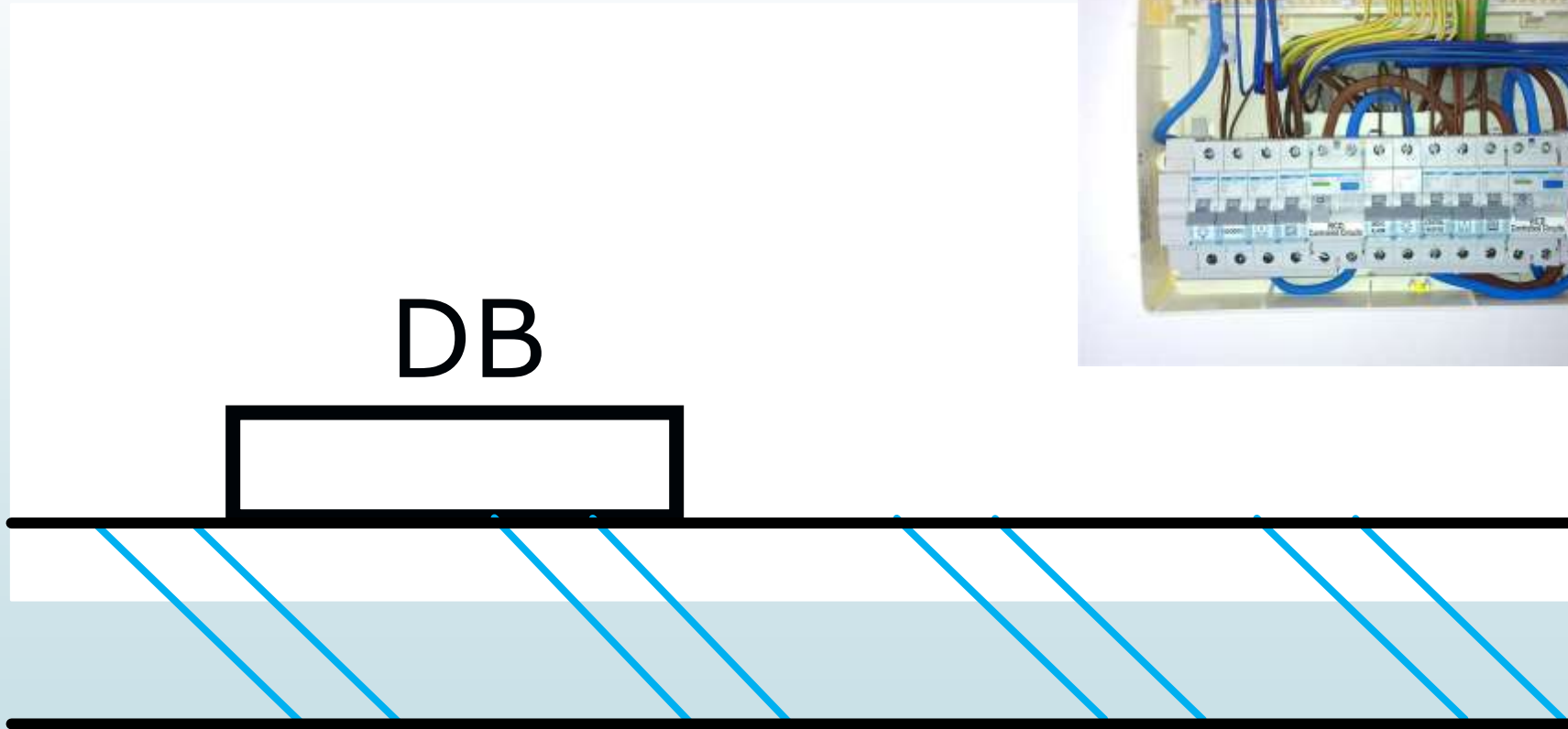
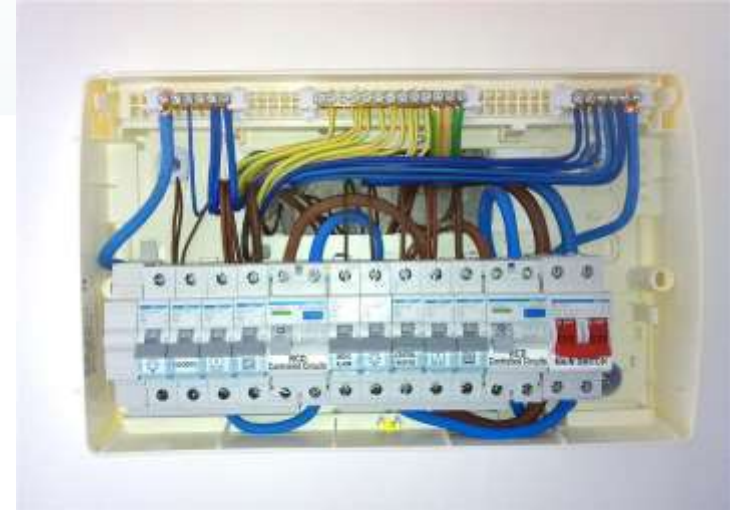

EARTH

- ➔ This unit detects a leakage of electricity down to earth.

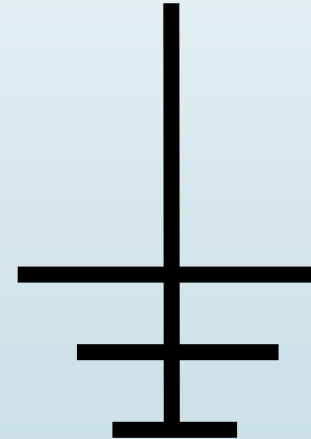

EARTH

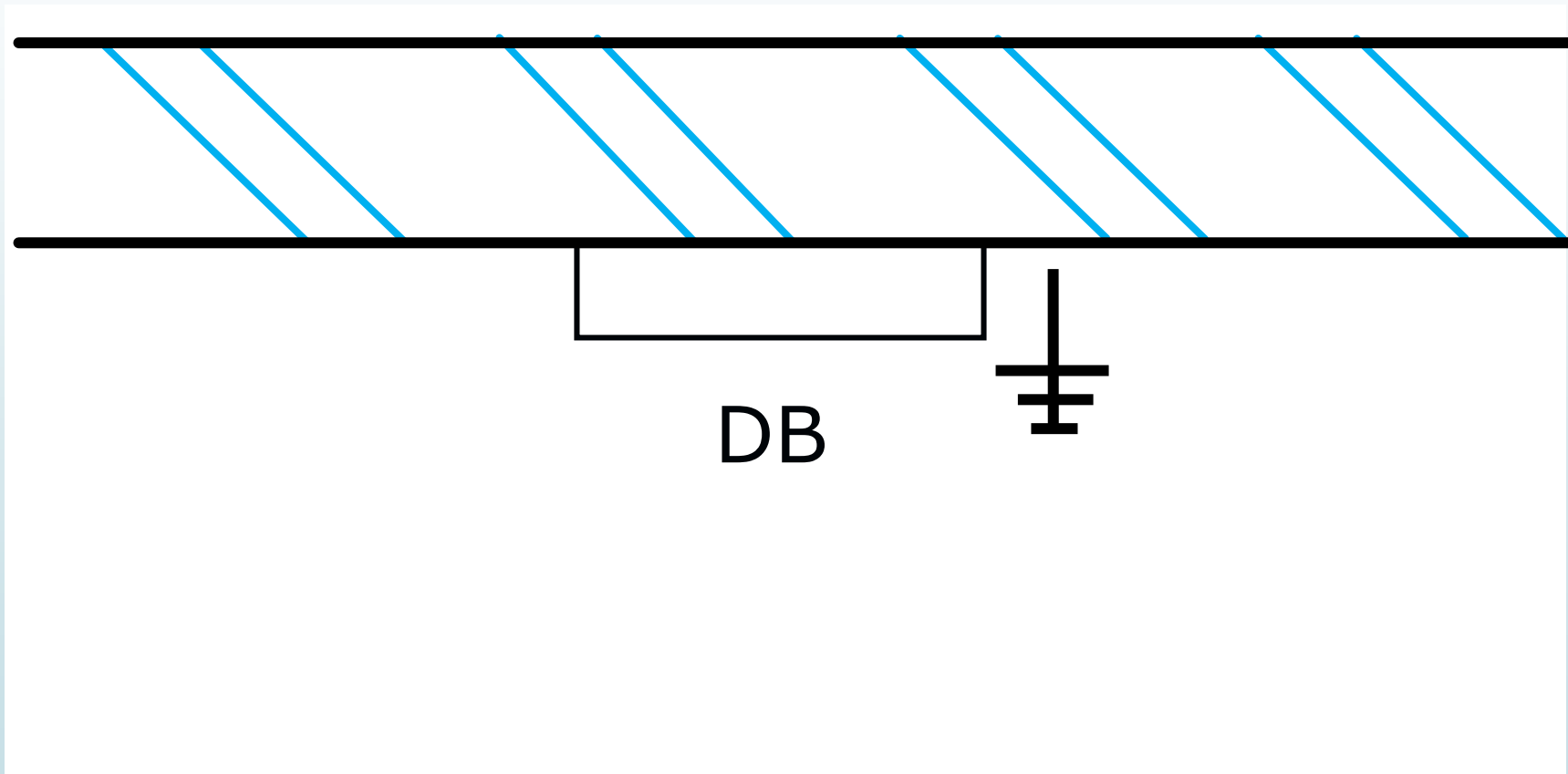

2 X FLUORESCENT LIGHTS (40W)

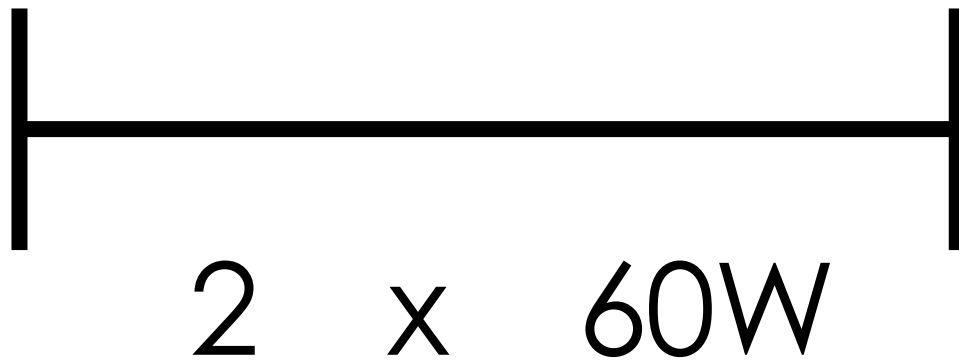

2 x 60W



education

Department of
Education
FREE STATE PROVINCE

HANGING CEILING LIGHTS

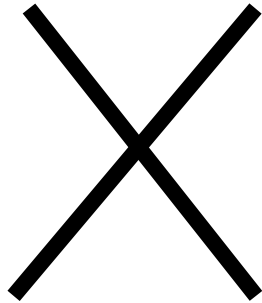

3 X HANGING CEILING LIGHTS (40 W)



3 X 40W

WALL MOUNTED LIGHTS

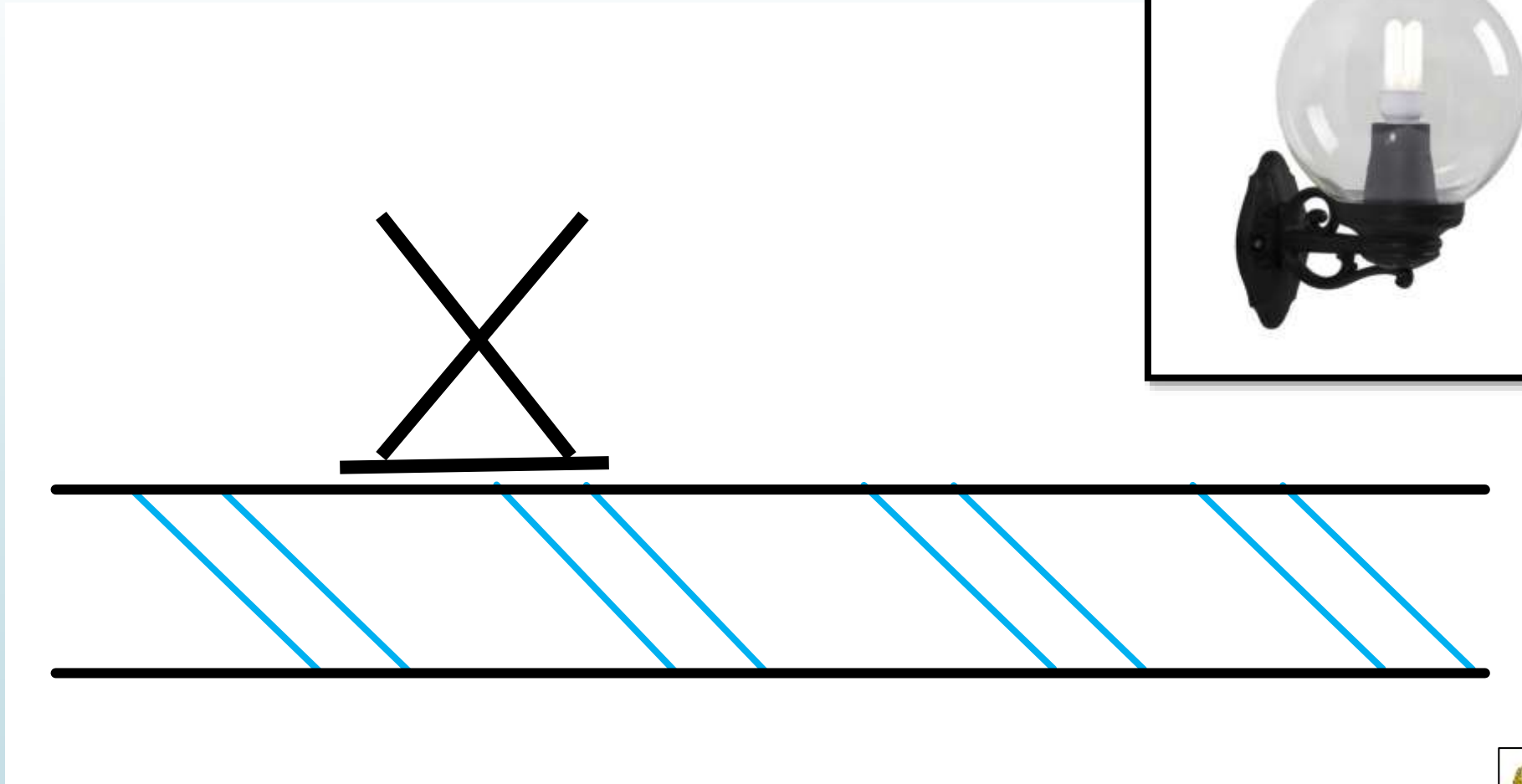

SWITCHES

- ▶ This device comes in various shapes and is used to break the flow of current in a circuit

ONE WAY SWITCH – ONE POLE

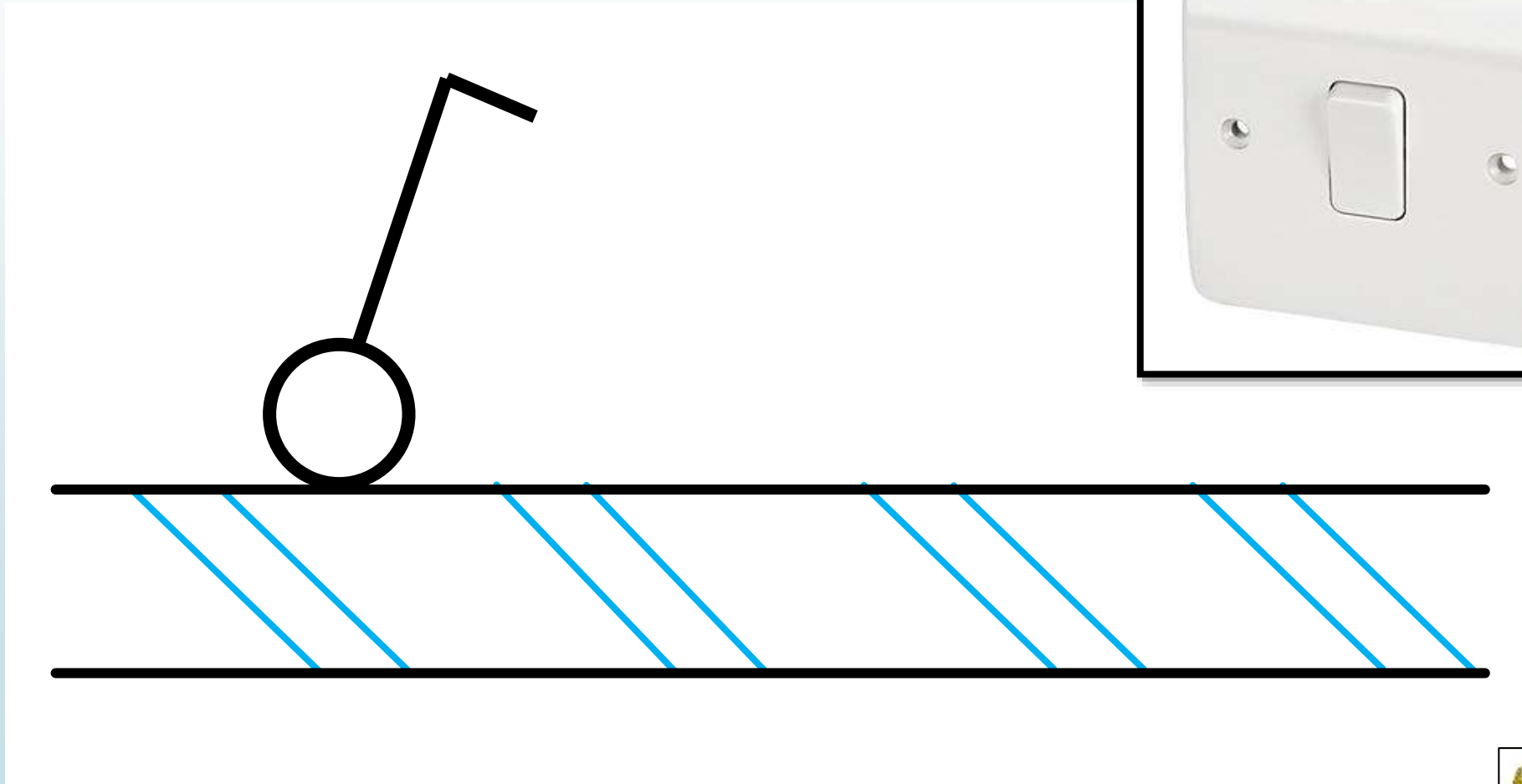

ONE WAY SWITCH – TWO POLE

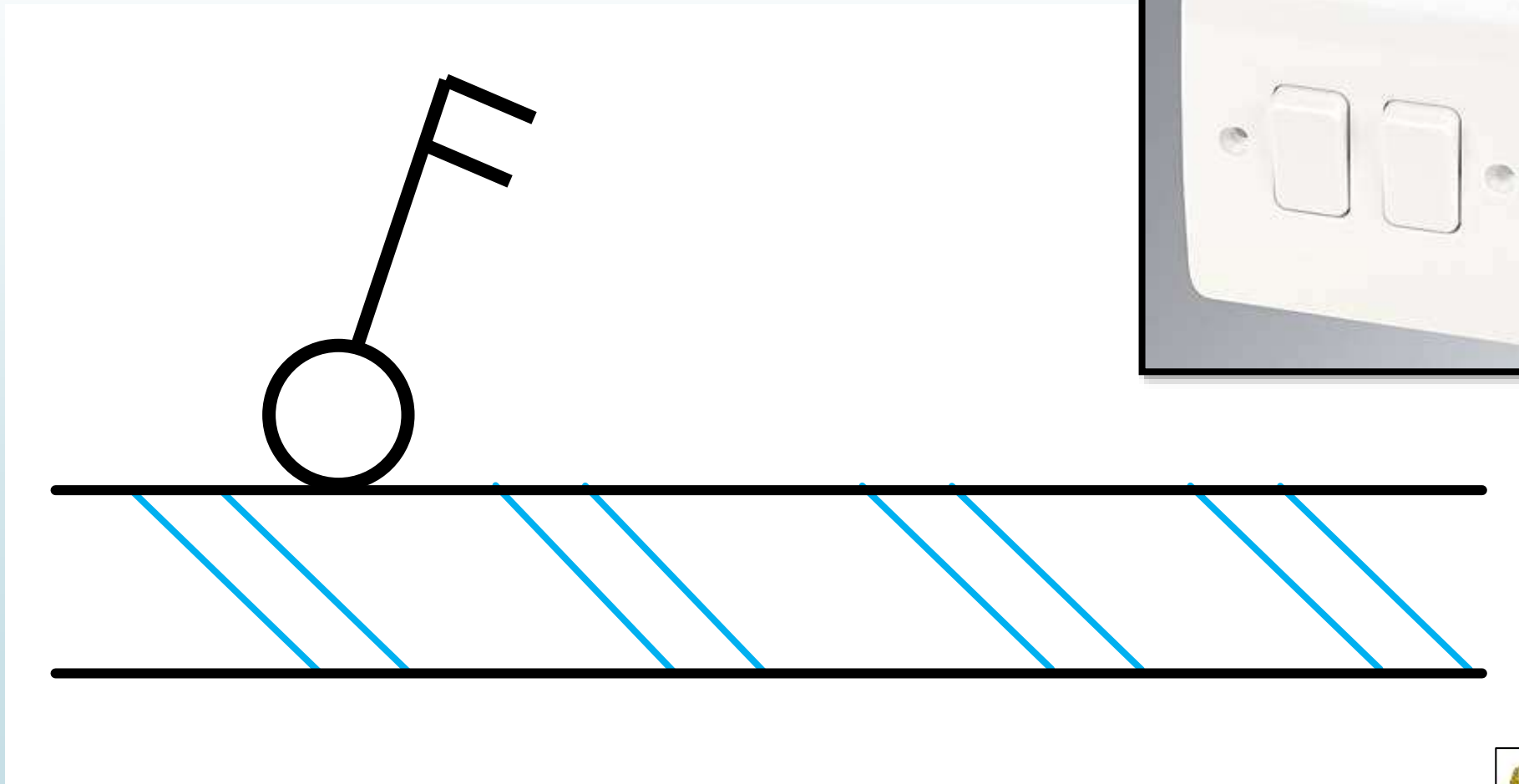

ONE WAY SWITCH – THREE POLE

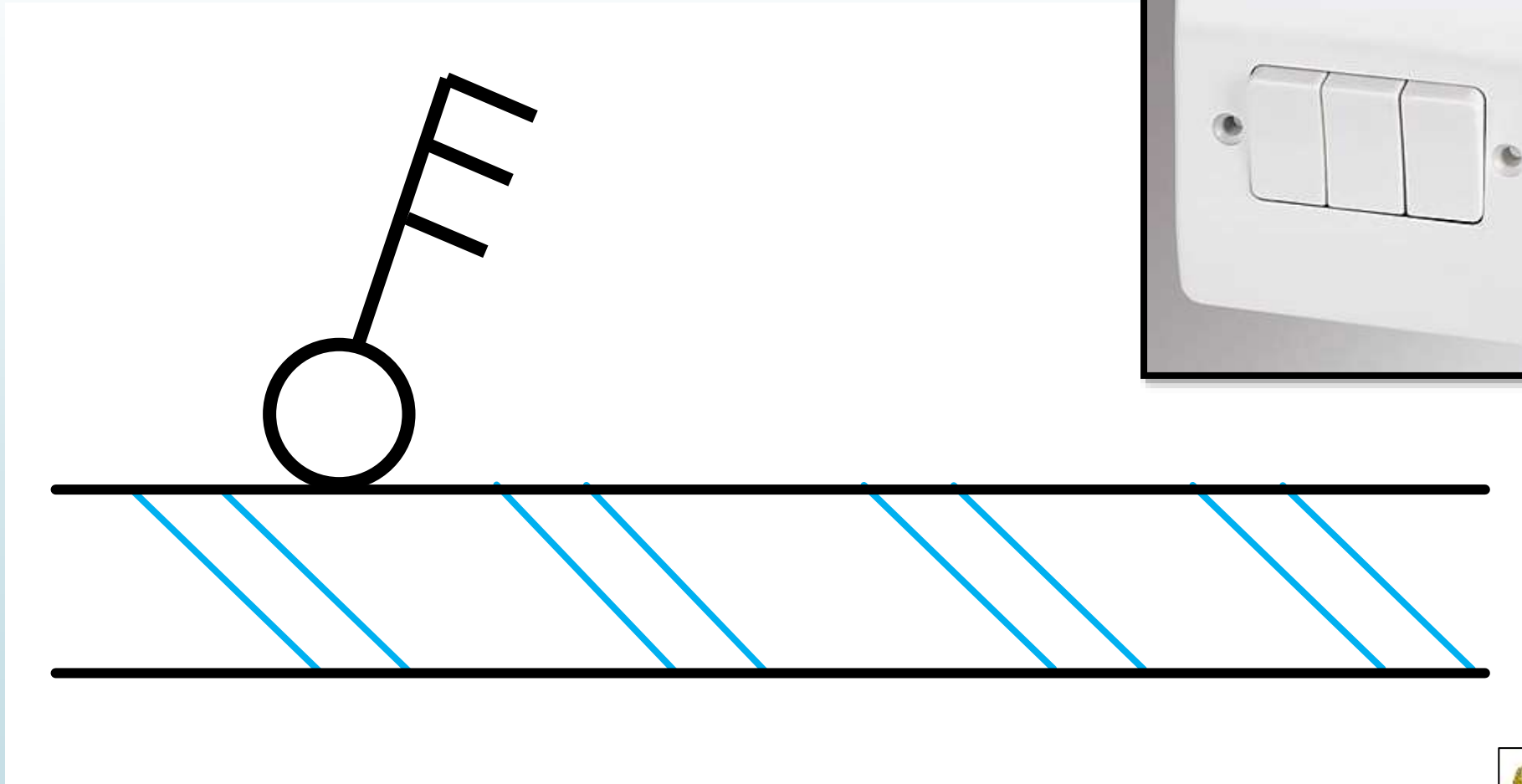

TWO WAY SWITCH

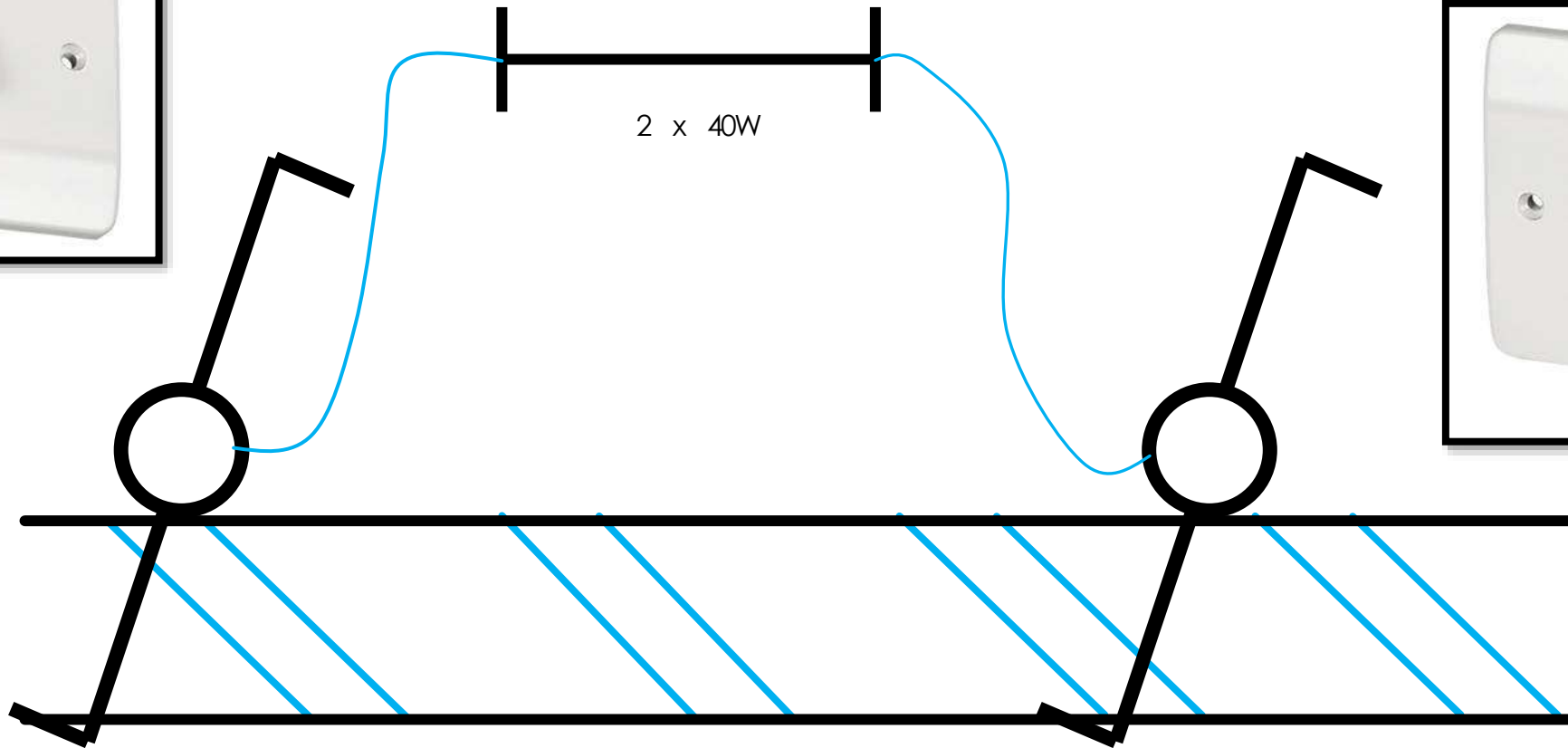

REGULATING SWITCH (DIMMER)

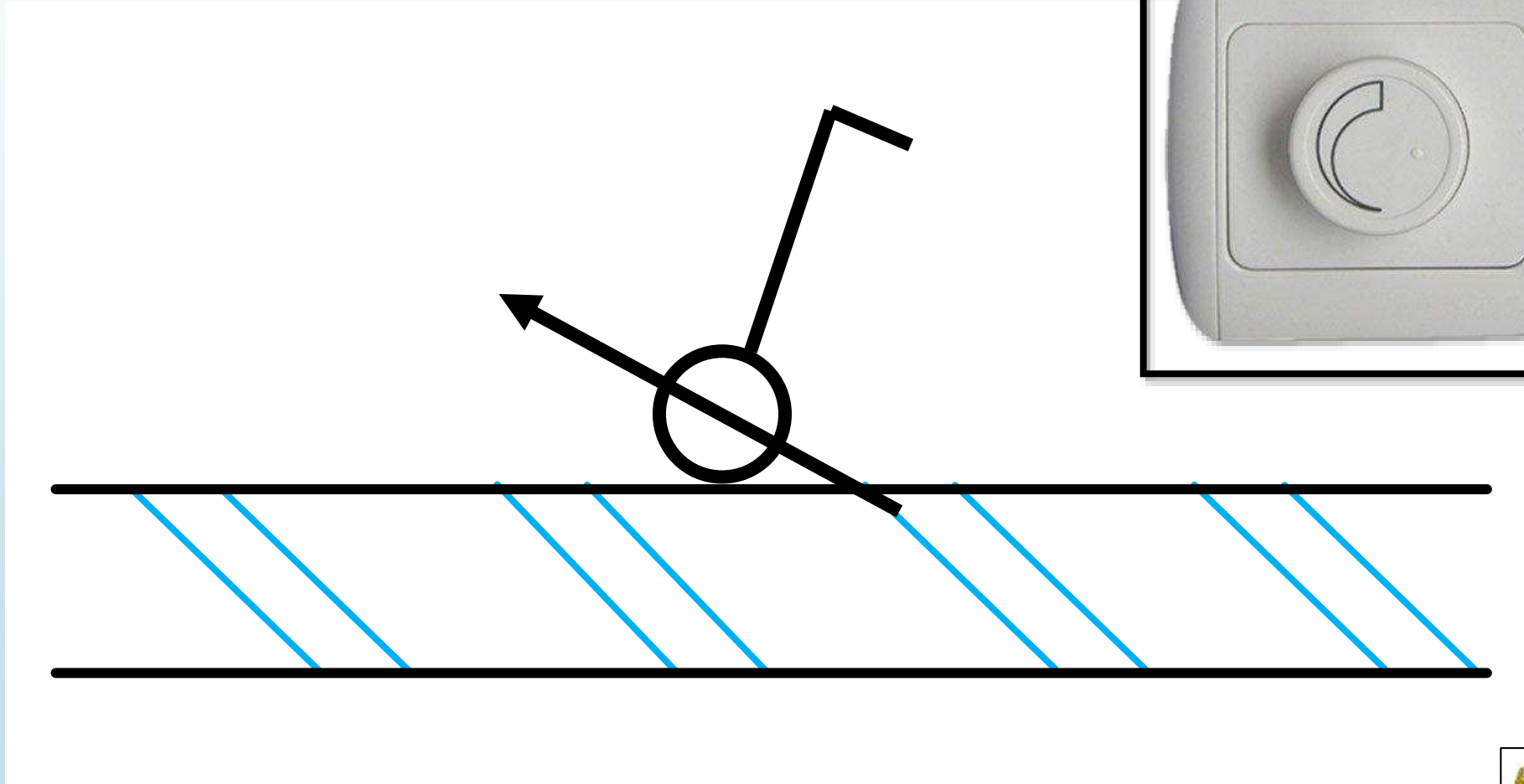

CONNECTING LIGHTS & SWITCHES

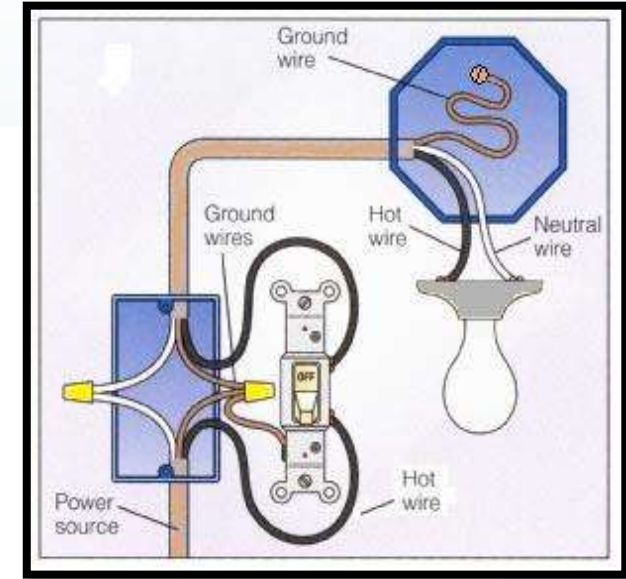
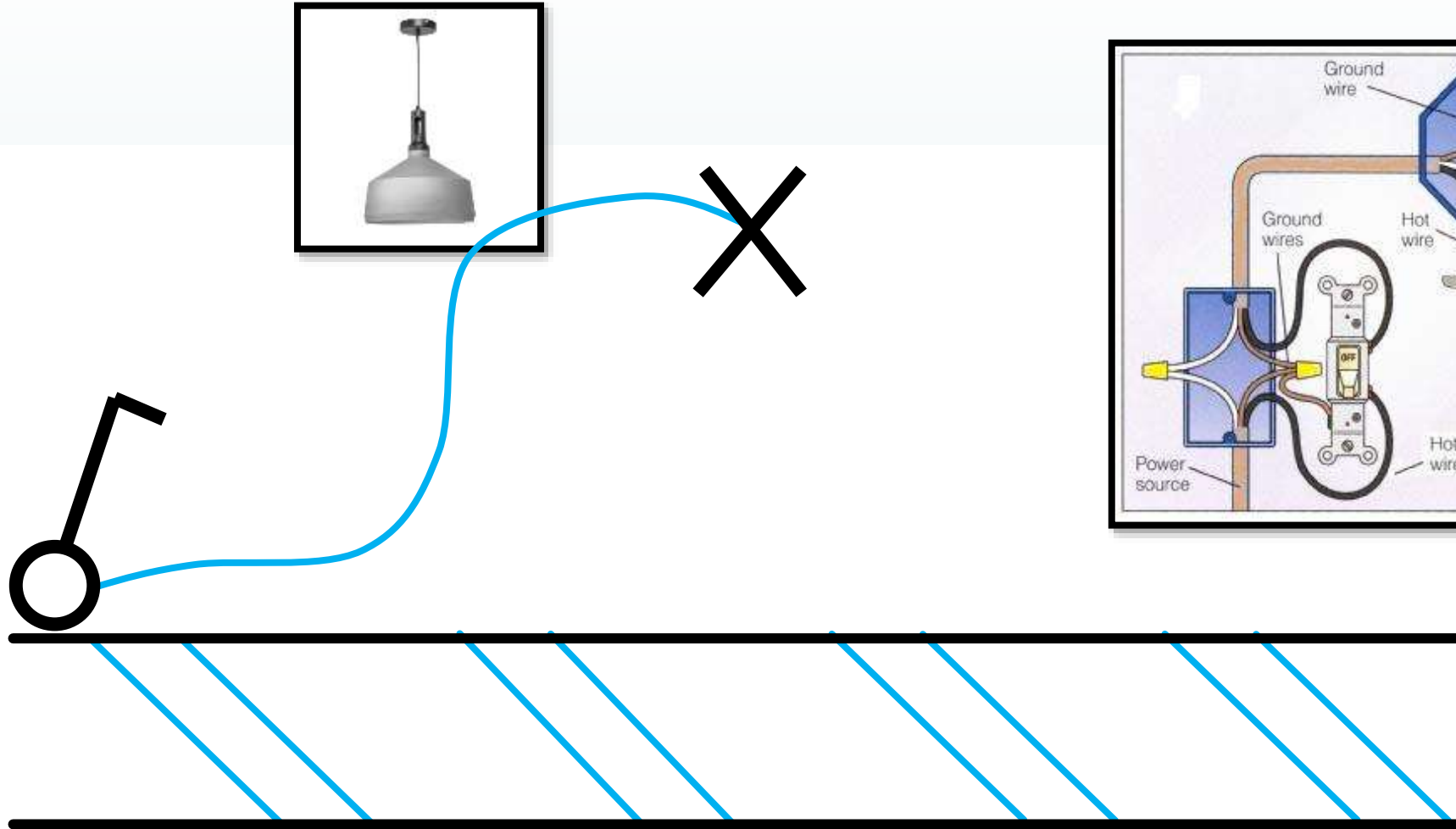

SWITCHED SOCKET OUTLET

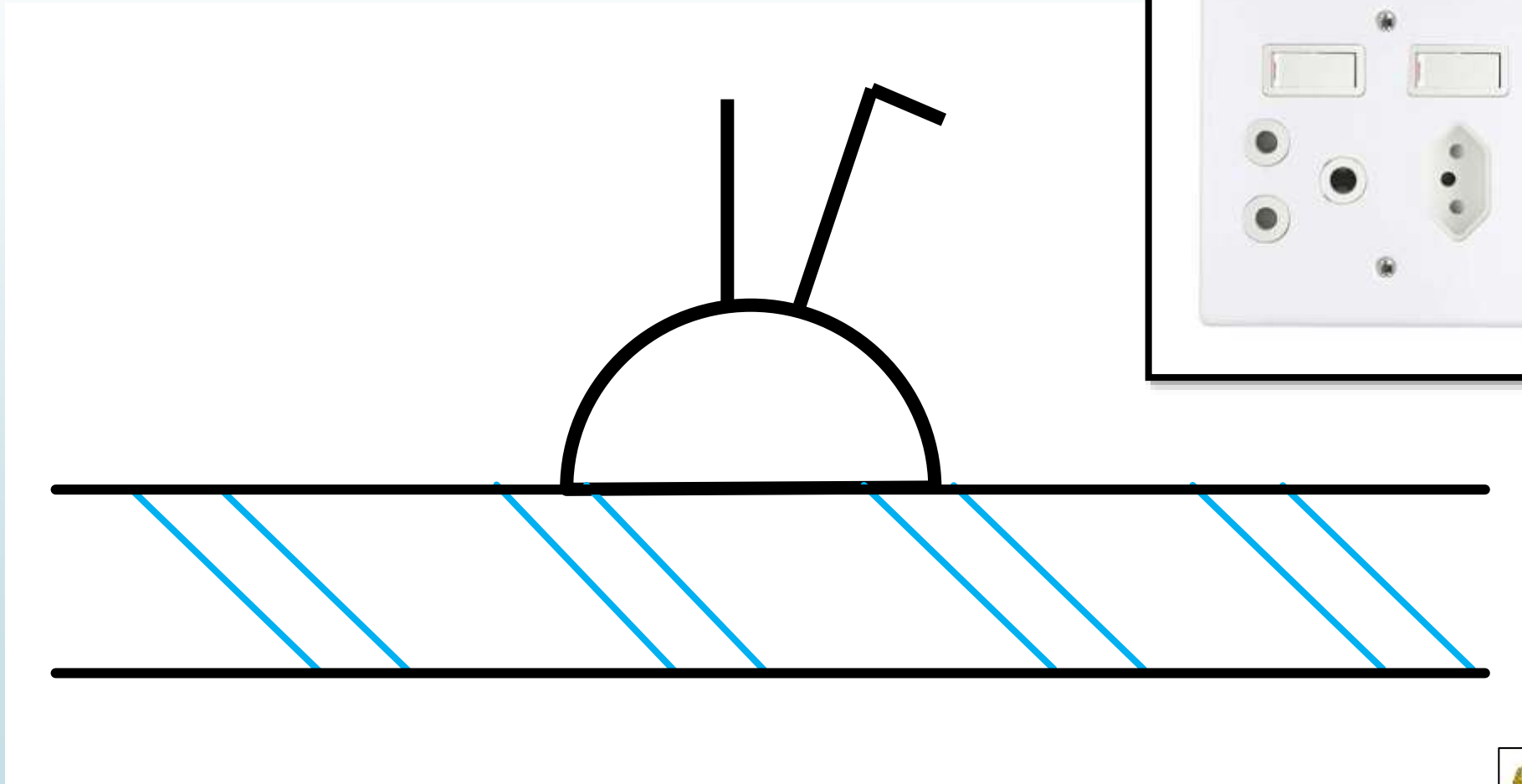

SOCKET OUTLET

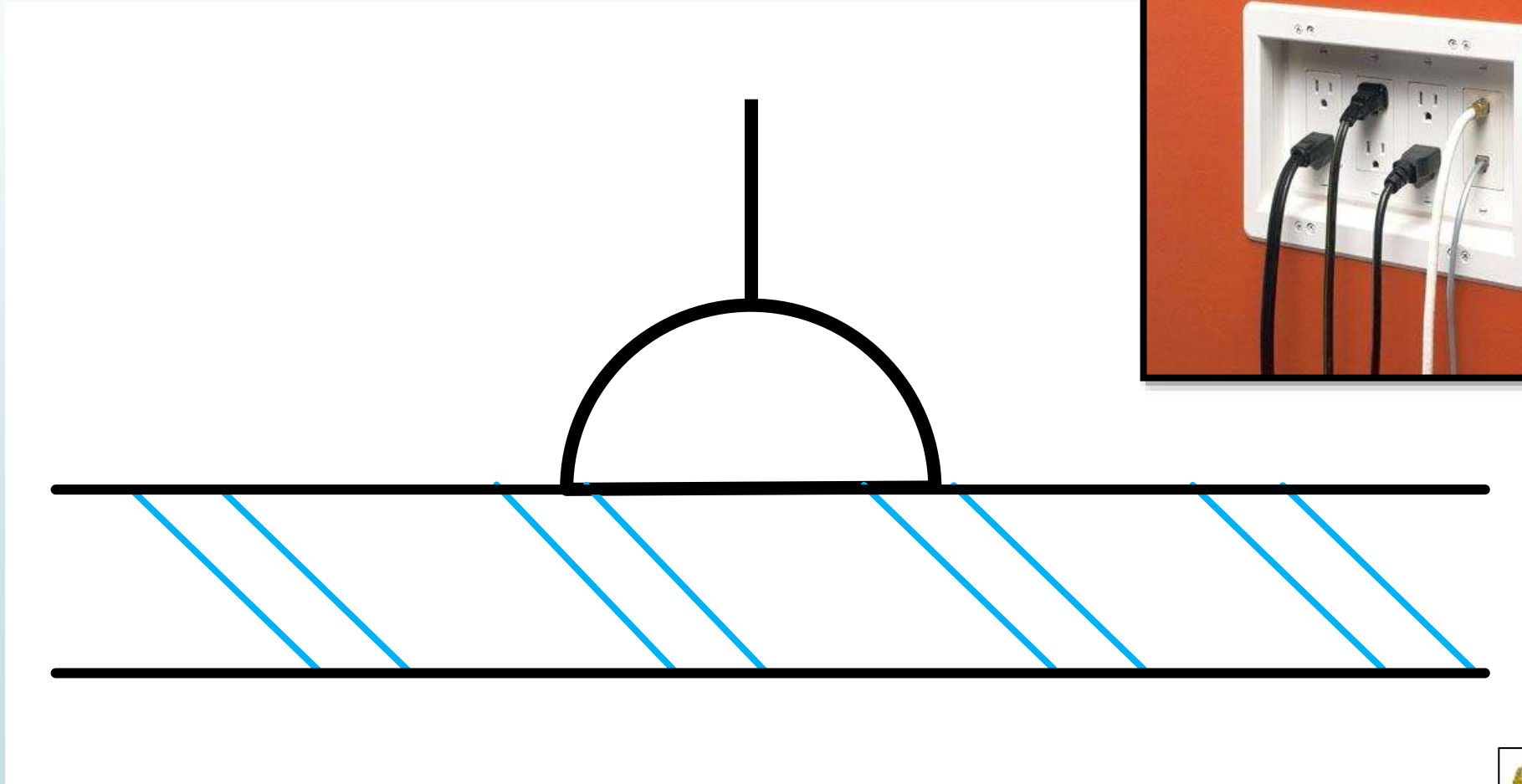

ELECTRICITY METER WATT-METER RECORDING

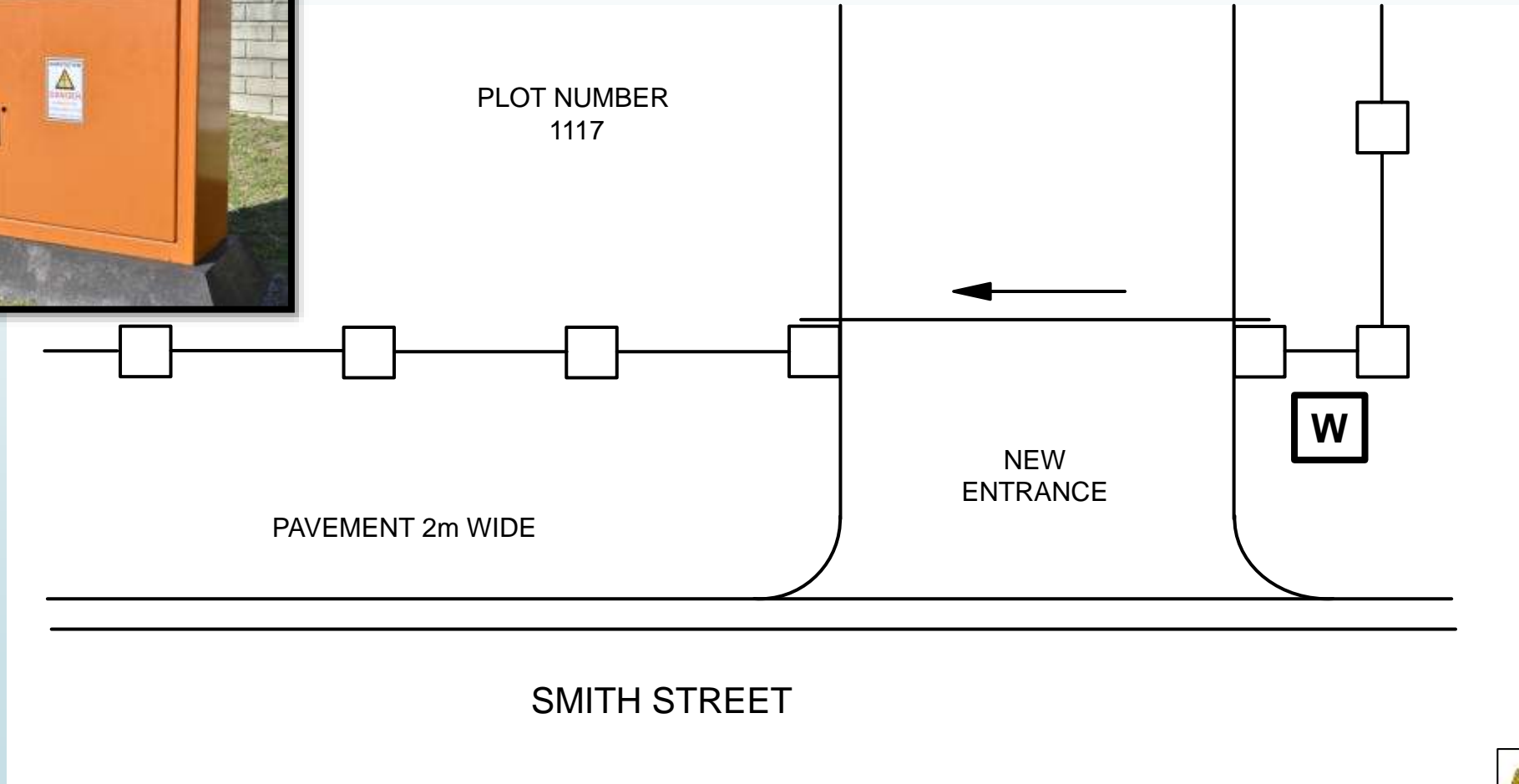

EMERGENCY LIGHTS

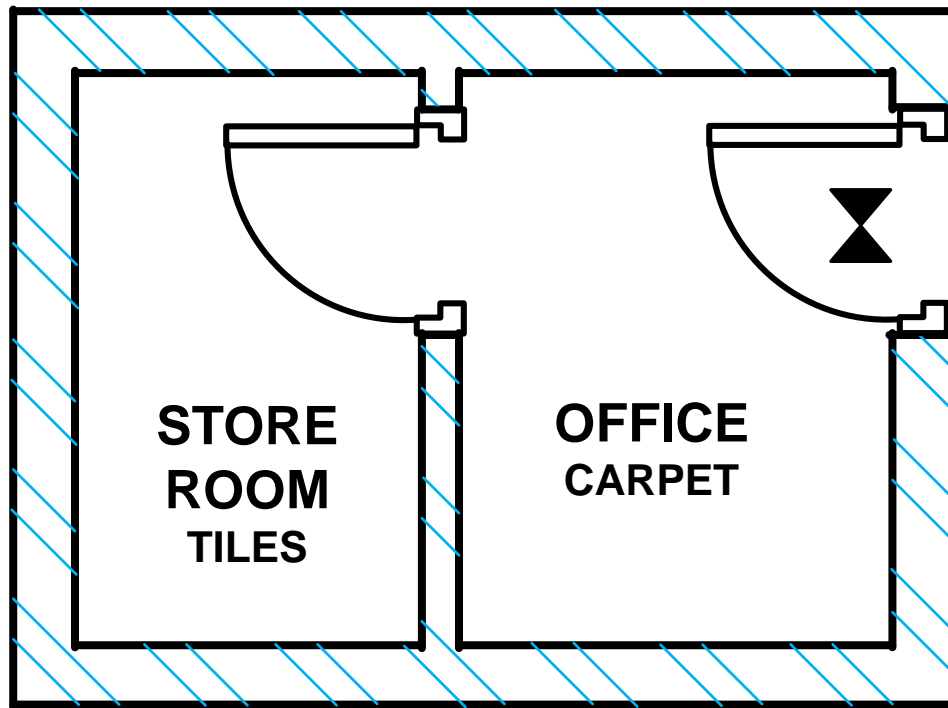

INTERNAL TELEPHONE

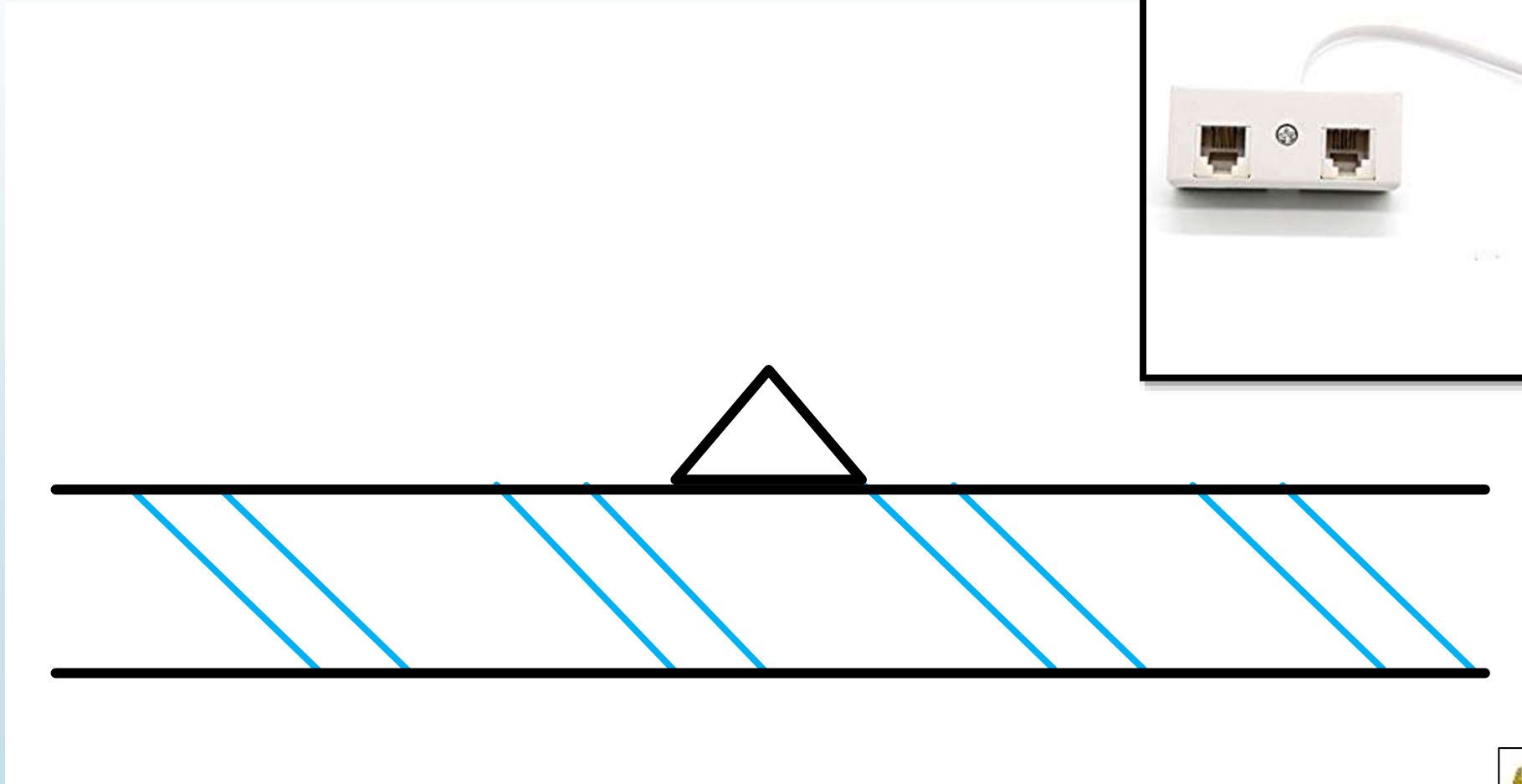

PUBLIC TELEPHONE

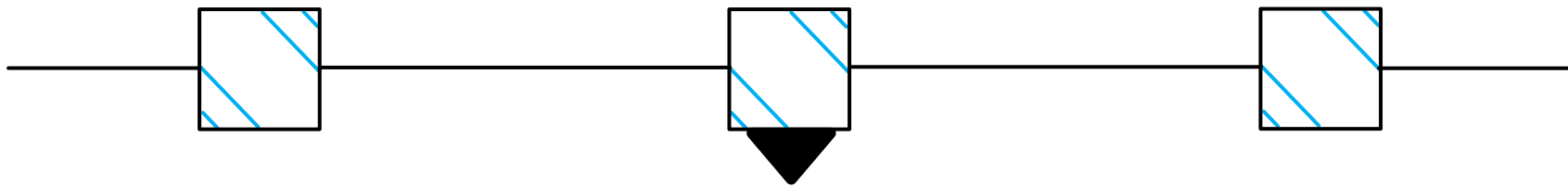

ELECTRICITY

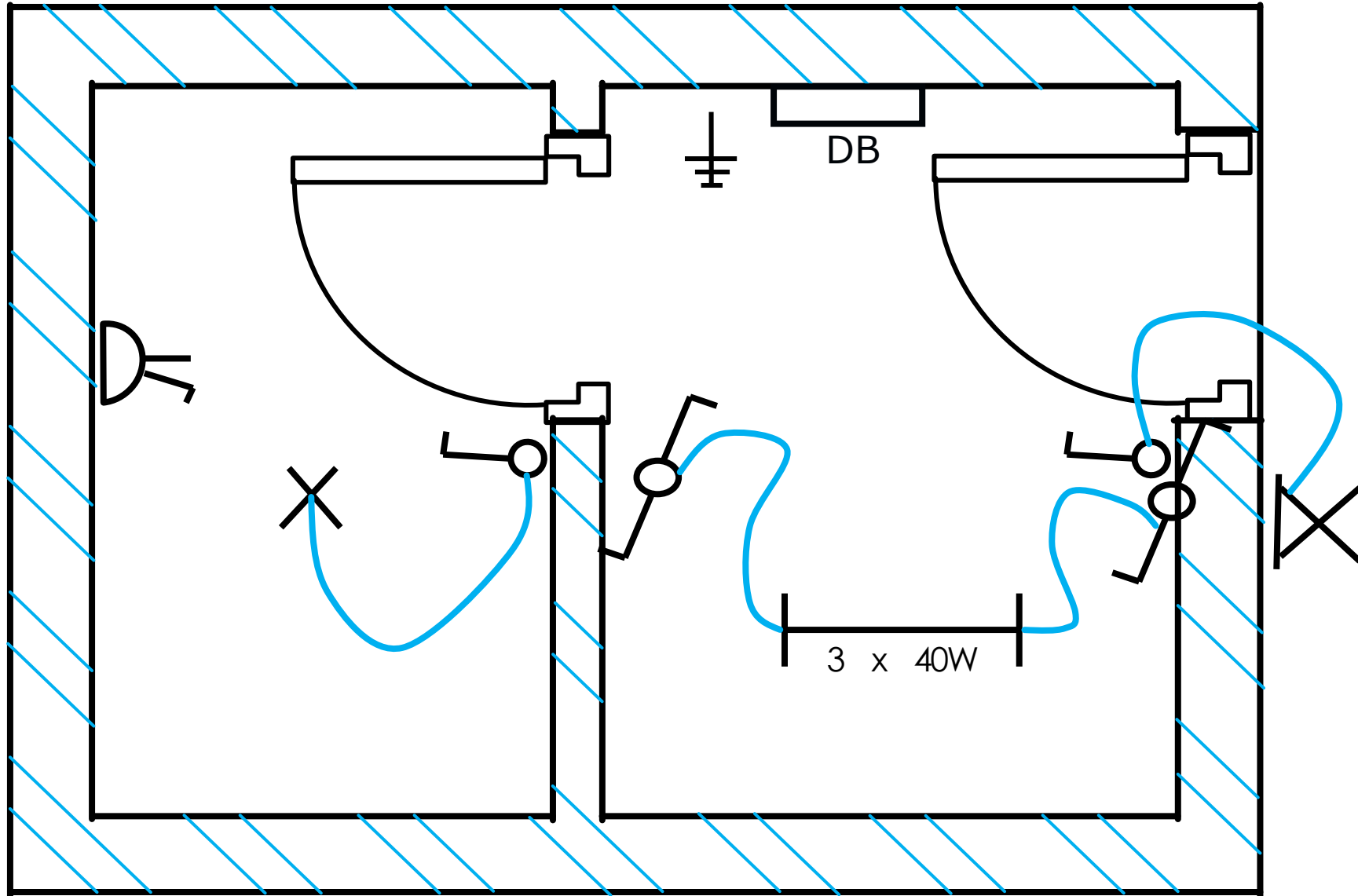

ELECTRICITY

