



EGD Grade 10, 11 & 12

B- line types &

C- line types

Developed by: PC Viljoen
Senior Educational Specialist for
Engineering Graphics and Design
Free State Province



education

Department of
Education
FREE STATE PROVINCE

Relevant line types

Line types are divided into

A-type lines



B-type lines



C-type lines



Relevant line types

- Different line types is used to express the drawing easier.
 - More important objects will be shown darker.
 - Less important objects will be shown lighter.



Relevant line types

- Drawing **B-lines** with a **pencil** should be **lighter**, finer and less visible than an A-type of line.
- Drawing **B-lines** in **black ink** will be **less thicker** than the A-line.
- For **explanation purposes** B-lines in this PowerPoint will be **blue**.

Relevant line types

- **B-lines** include
 - Chain lines to indicate...
 - the **centre of a circle**

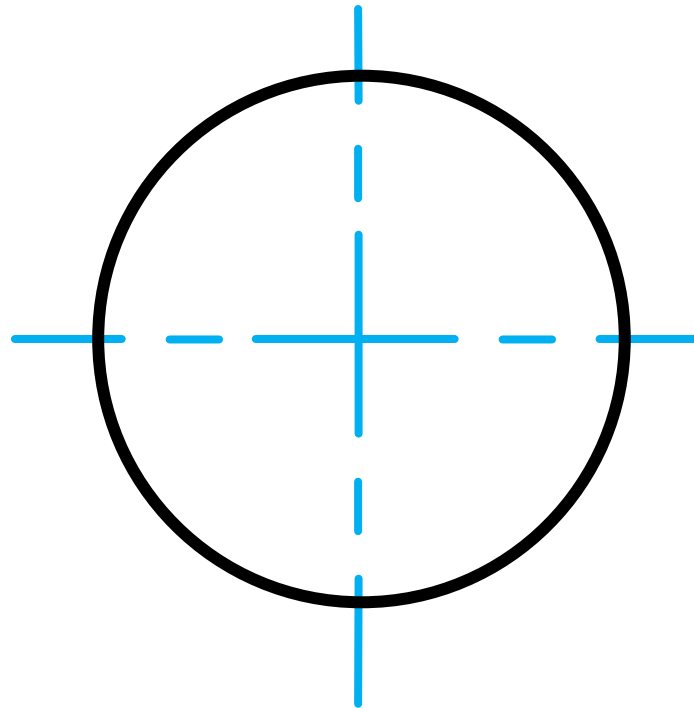

Relevant line types

- **B-lines** include
 - Chain lines to indicate...
 - the **centre of axis**

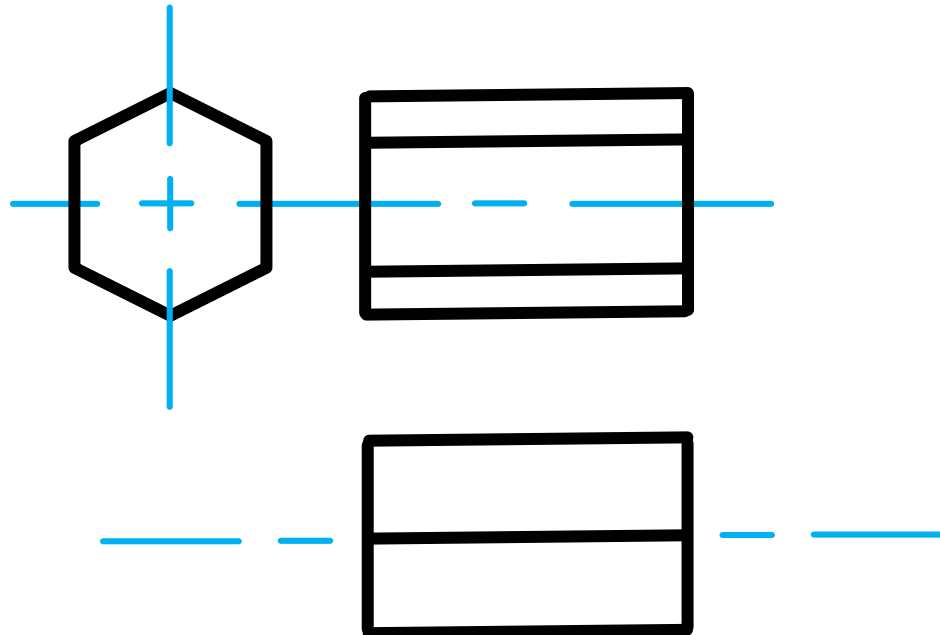

Relevant line types

- **B-lines** include
 - Chain lines to indicate...
 - the **symmetry** of a drawing

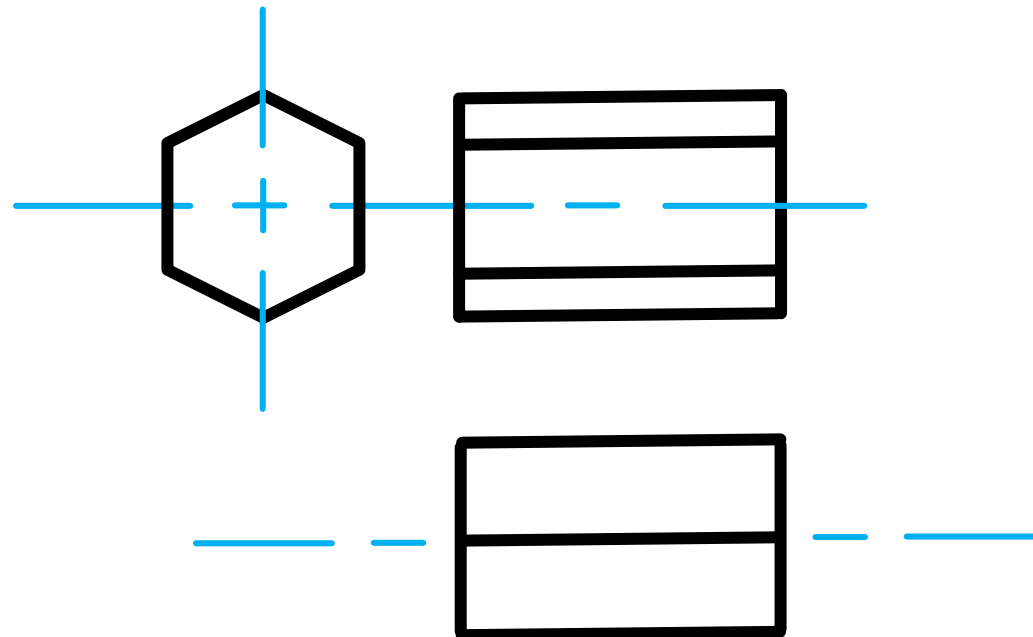

Relevant line types

➔ **B-lines** include

- ➔ Therefore save time by drawing the one half of a **symmetrical** drawing together with the **line of symmetry**

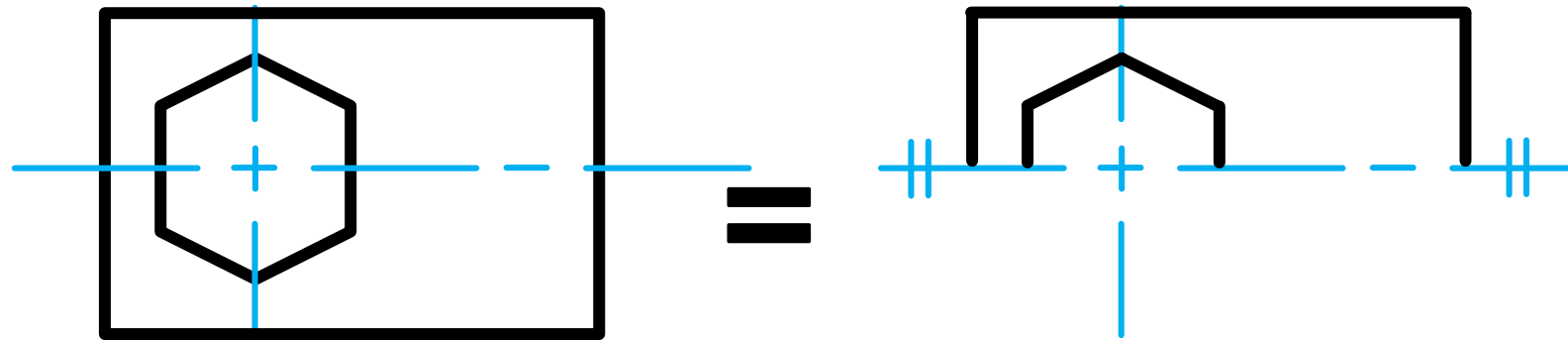

Relevant line types

- **B-lines** include
 - Chain lines to indicate...
 - the **track of a rotating crank**

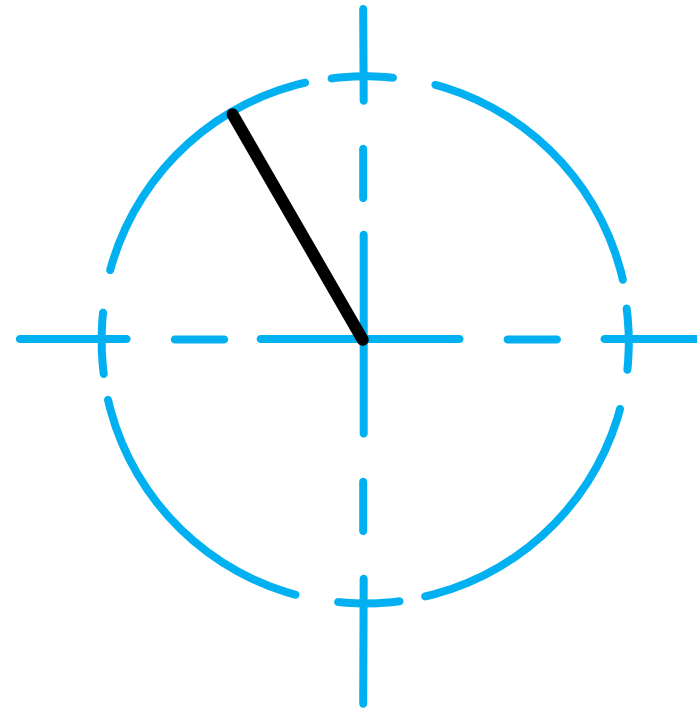

Relevant line types

- The **centre line** is shown in **medium chain-lines** (B-type) of ± 20 mm line, ± 4 mm gap and ± 4 mm line repetitive.



Relevant line types

- ▶ Medium chain lines will always **start & end** with a **long line**.



Relevant line types

- ➔ **B-lines** include
 - ➔ All lettering, numbering and dimension lines

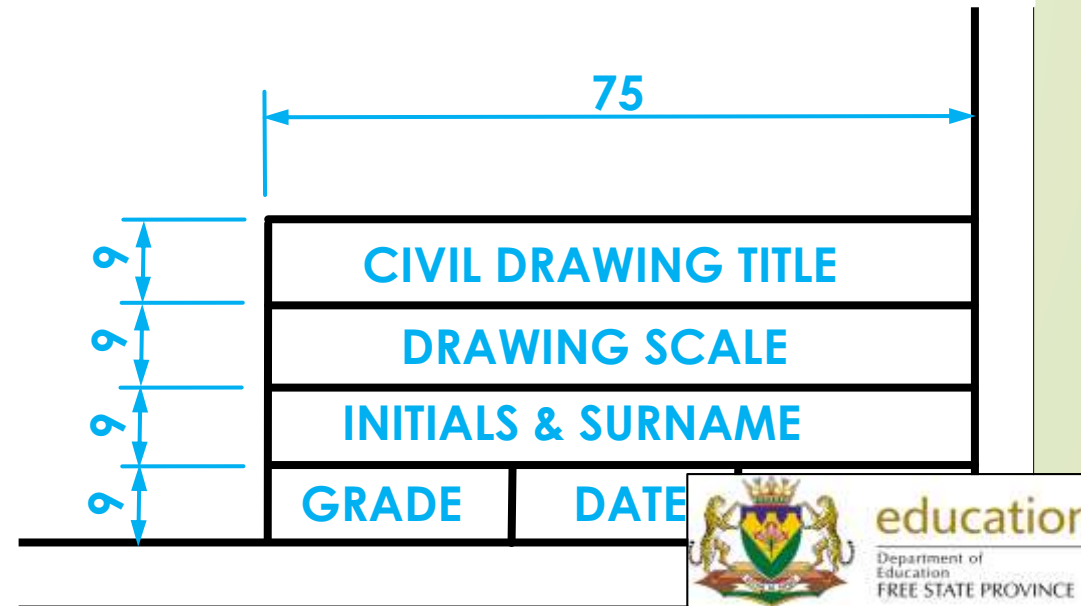

Relevant line types

- ➔ **B-lines** include
 - ➔ All **auxiliary views**

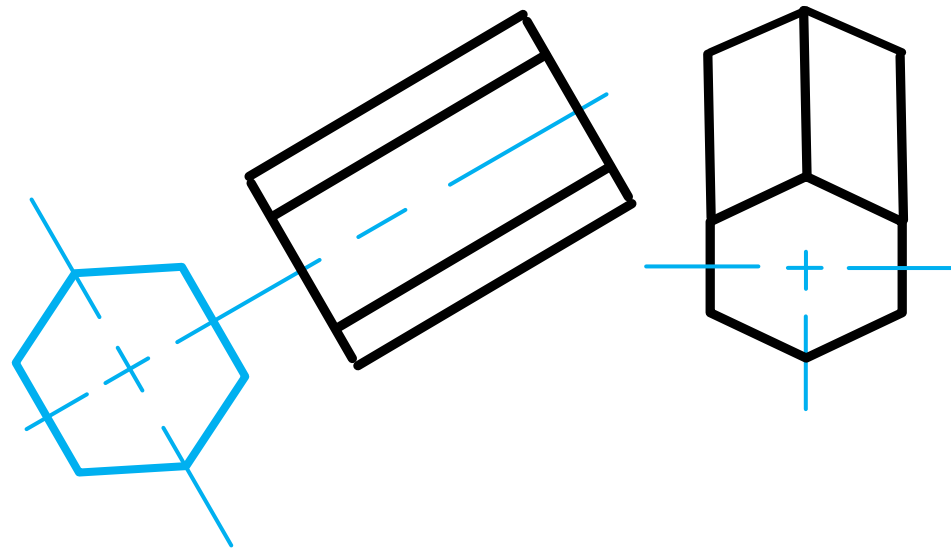

Relevant line types

- ➔ **B-lines** include
 - ➔ All **cutting planes** (First-Angle Orthographic Projection (F.A.O.P.))

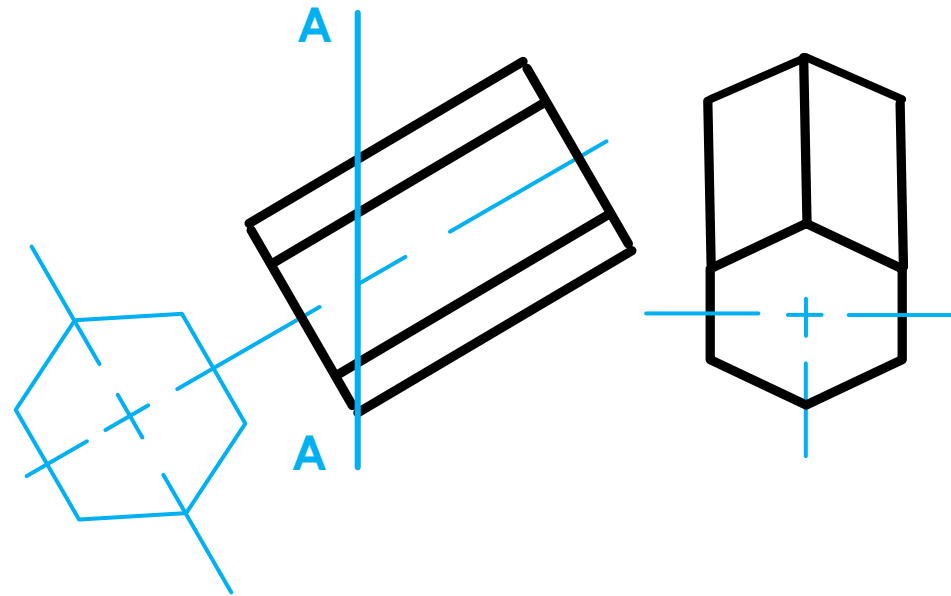

Relevant line types

- ➔ **B-lines** include
 - ➔ All **cutting planes** (Third-Angle Orthographic projection (T.A.O.P.))

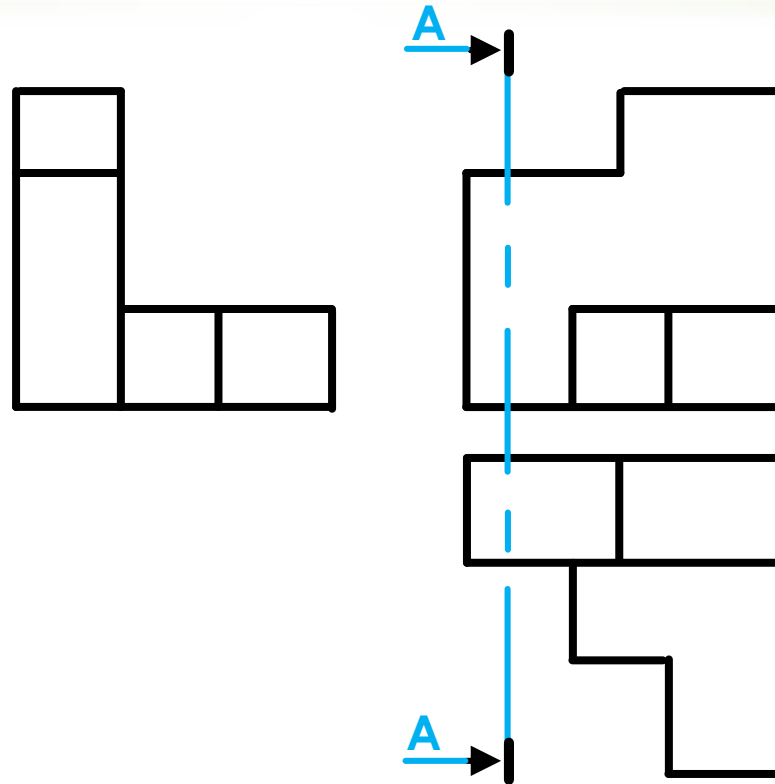

Mechanical Drawings (sectioning)

- ➔ In T.A.O.P. the **cutting plane** is shown in **medium chain-lines** (B-type) of ± 20 mm line, ± 4 mm gap and ± 4 mm line.

T.A.O.P. = Third-
Angle Orthographic
Projection



Mechanical Drawings (sectioning)

- ➔ Medium chain lines will always **start & end** with a **long line**.



Mechanical Drawings (sectioning)

- ➔ In **F.A.O.P.** the **cutting plane** is shown as a **solid line**

F.A.O.P. = First-Angle
Orthographic
Projection

Mechanical Drawings (sectioning)

- ➔ The cutting plane line must be **emphasised** at both **ends**.

F.A.O.P. = First-Angle Orthographic Projection

T.A.O.P. = Third-Angle Orthographic Projection



education

Department of
Education
FREE STATE PROVINCE

Mechanical Drawings (sectioning)

- ➔ The **arrows** of the cutting plane is larger than dimension arrows.

F.A.O.P. = First-Angle Orthographic Projection

T.A.O.P. = Third-Angle Orthographic Projection



Mechanical Drawings (sectioning)

- ➔ The **tail** part of the arrows must be B type line quality.

F.A.O.P. = First-Angle Orthographic Projection

T.A.O.P. = Third-Angle Orthographic Projection

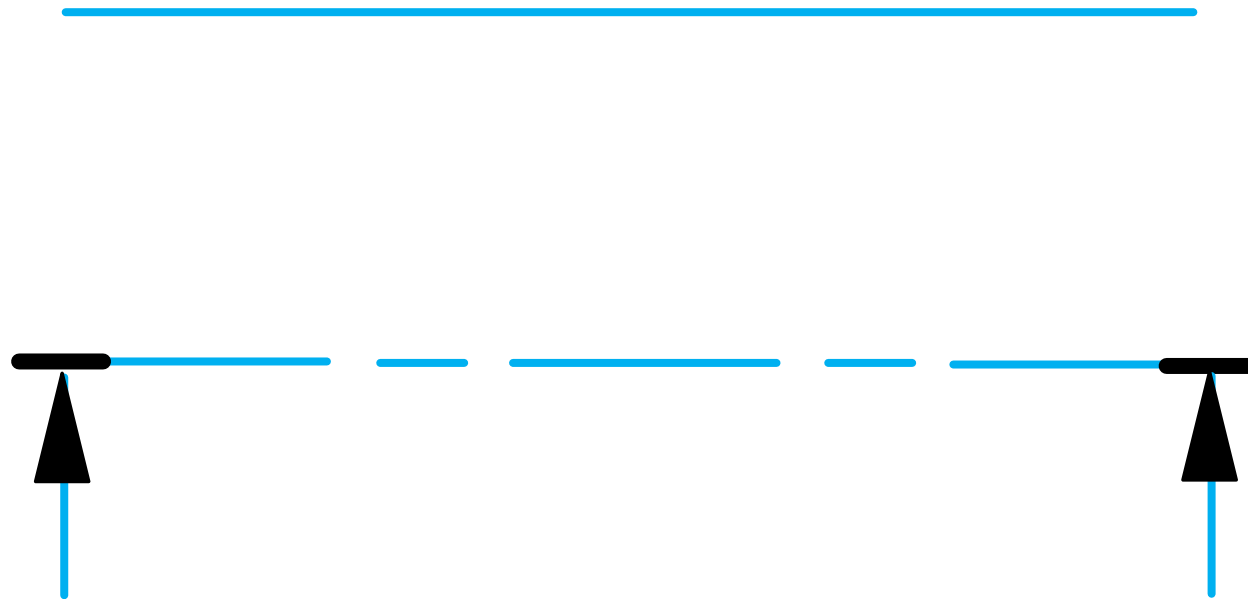

education

Department of
Education
FREE STATE PROVINCE

Mechanical Drawings (sectioning)

- ➔ The **arrows** on the cutting plane will **point** towards the **remaining portion** of the object.

F.A.O.P. = First-Angle Orthographic Projection

T.A.O.P. = Third-Angle Orthographic Projection



Relevant line types

- ➔ **B-lines** include
 - ➔ All hatch lines

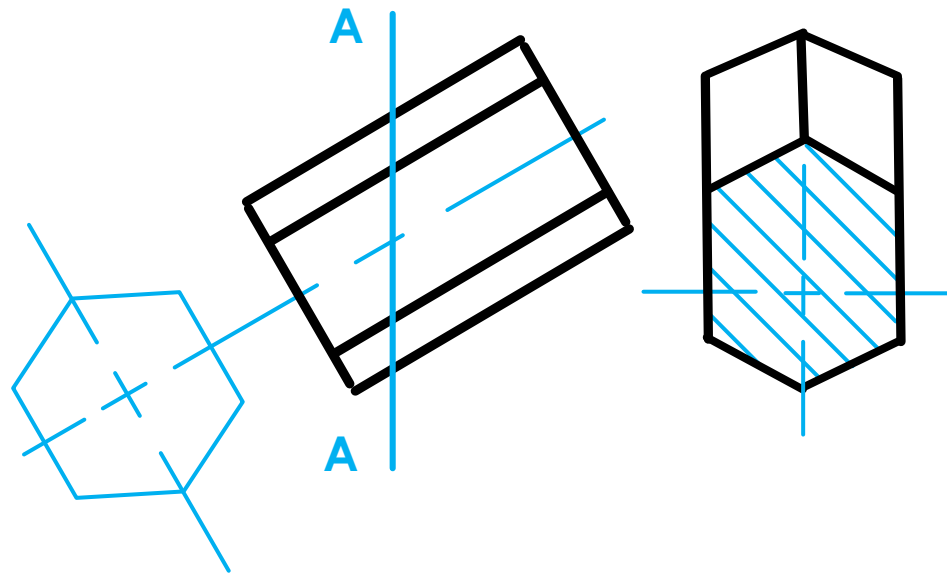

Relevant line types

- ➔ **B-lines** include
 - ➔ All hatch lines

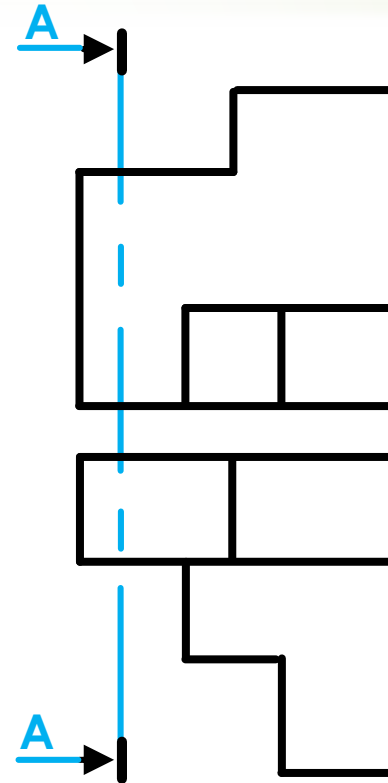
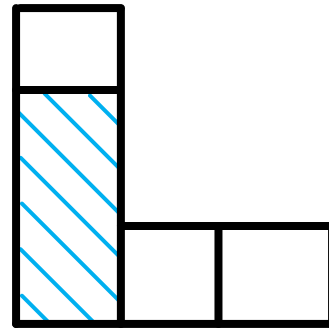

Relevant line types

- **B-lines** include
 - All **hatch lines** in civil drawings

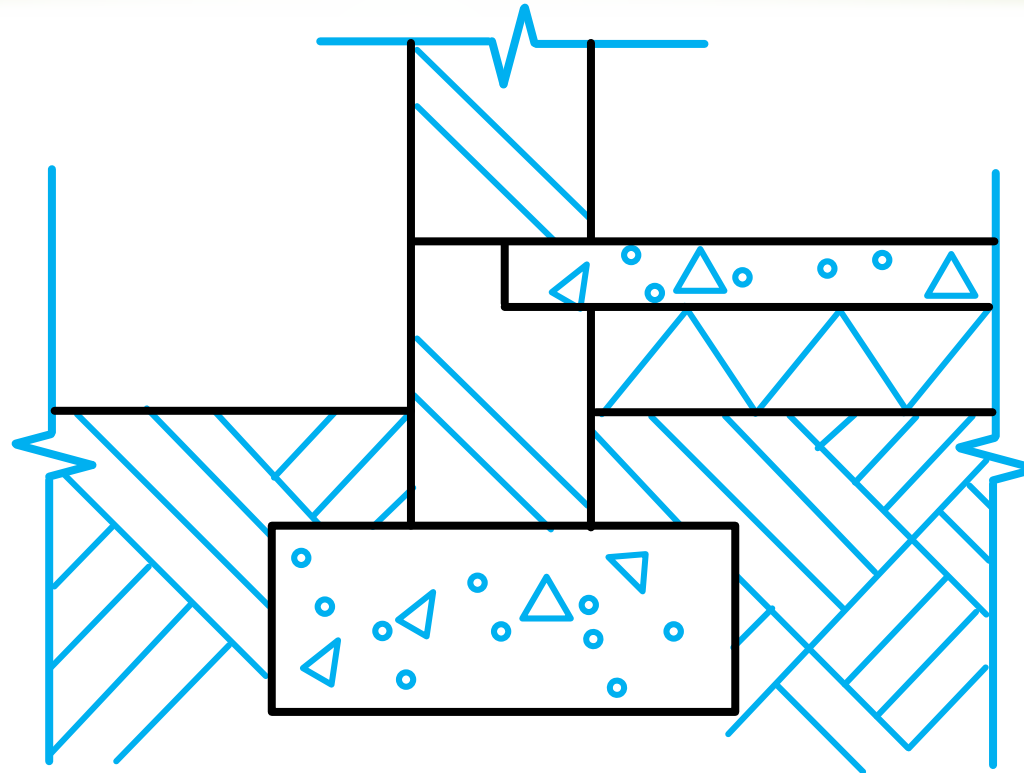

Relevant line types

- ➔ **B-lines** include
 - ➔ **All threads**

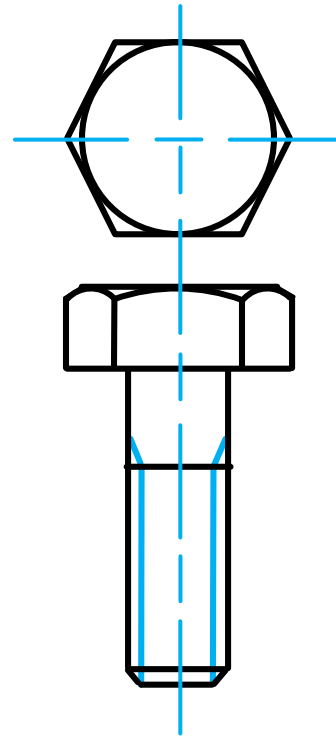

Relevant line types

- ➔ **B-lines** include
 - ➔ **Folding lines**

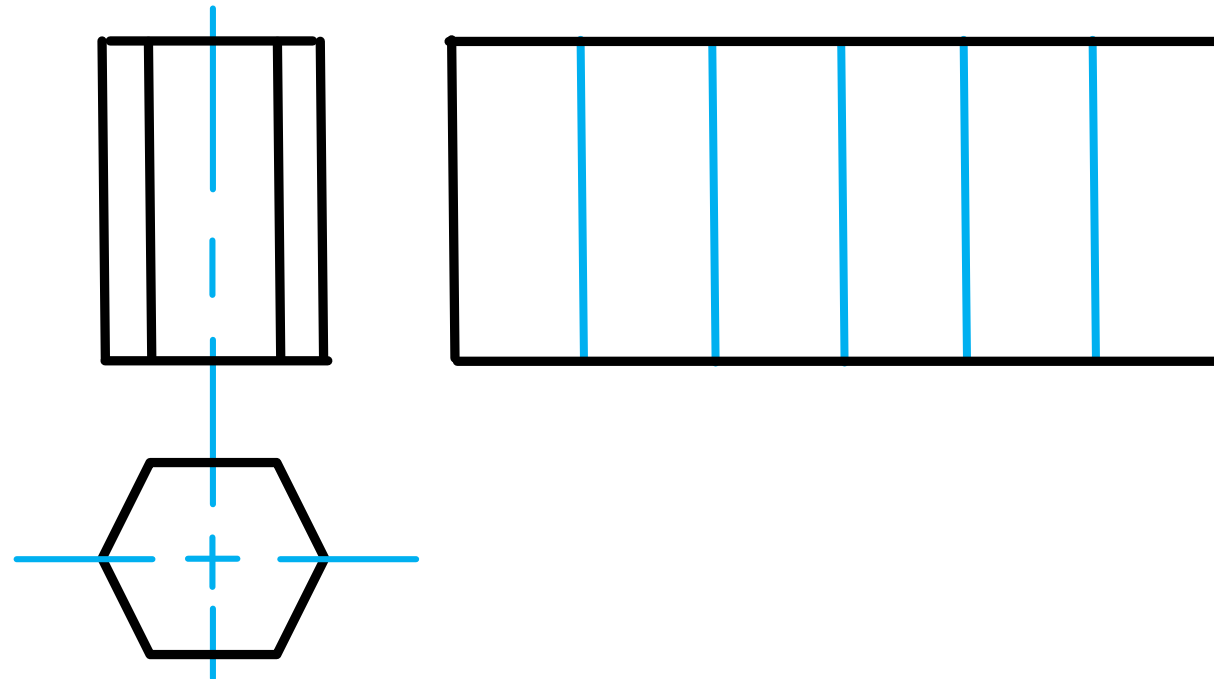

Relevant line types

- ➔ **B-lines** include
 - ➔ **Break lines**

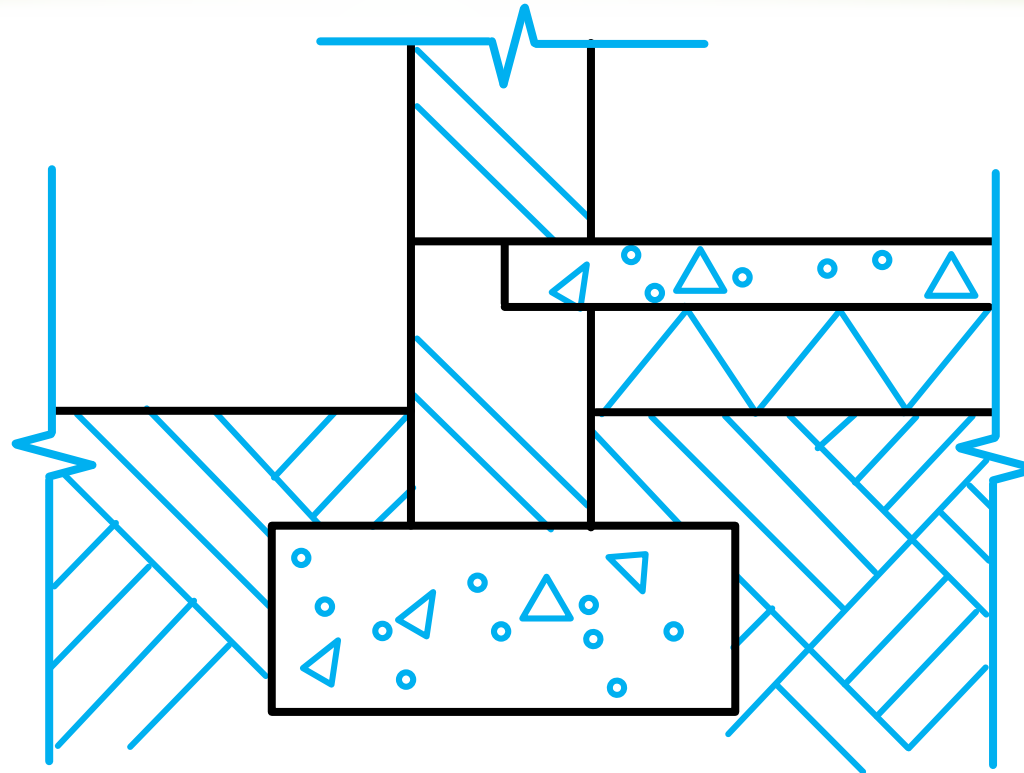

Relevant line types

- ➔ **B-lines** include
 - ➔ Chain lines on a civil to indicate...
 - ➔ the **build lines** and **servitudes** drawing.

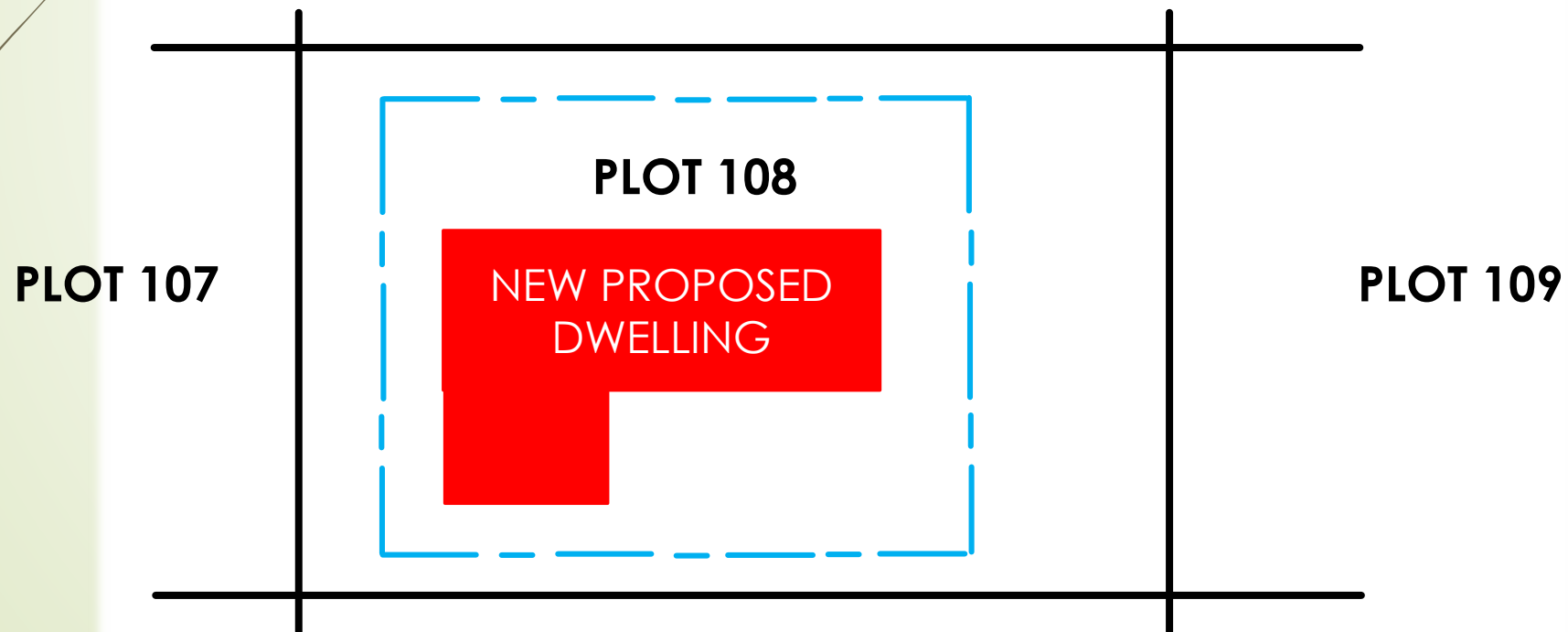

Relevant line types

- ➔ **B-lines** include
 - ➔ Showing the **position** of **projection planes**

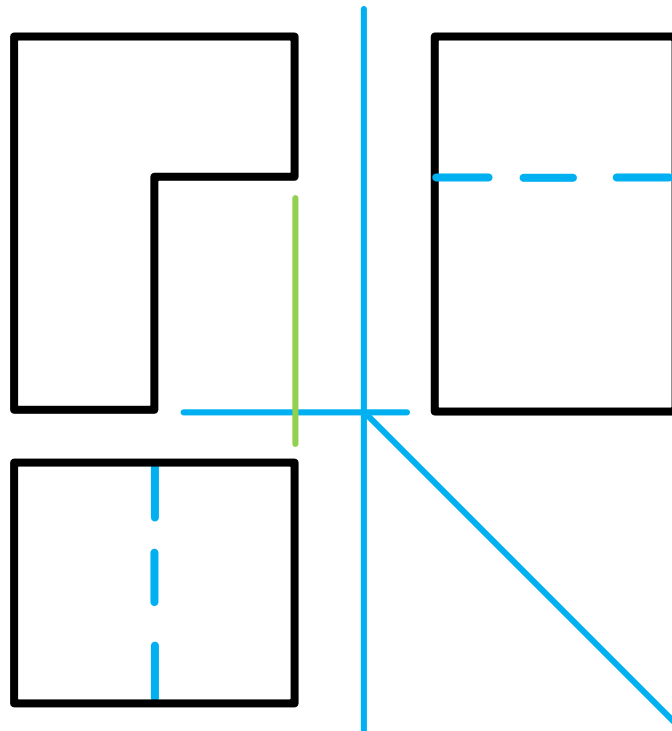

Relevant line types

- **B-lines** include
 - Short broken-lines to indicate...
 - **Hidden detail** on a drawing

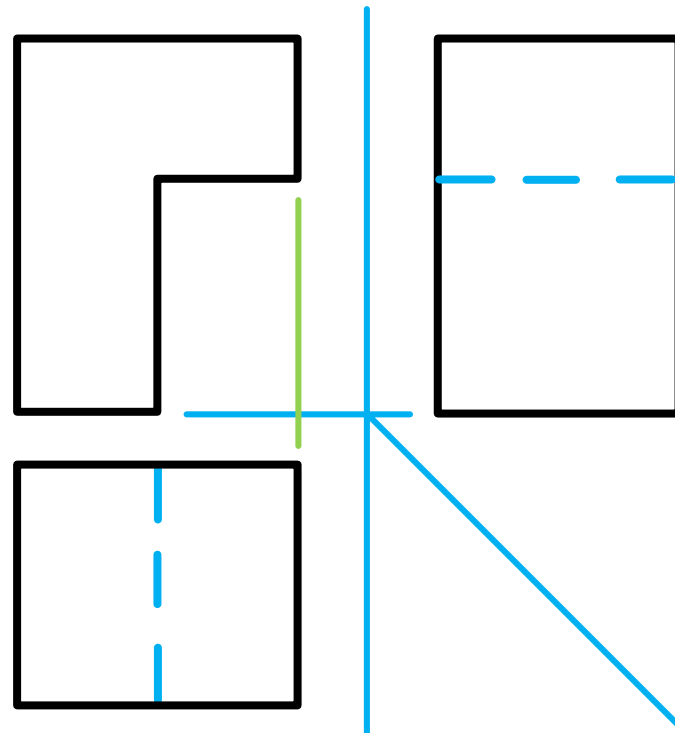

Relevant line types

- **B-lines** include
 - Short broken-lines to indicate...
 - Items to be removed on civil drawings

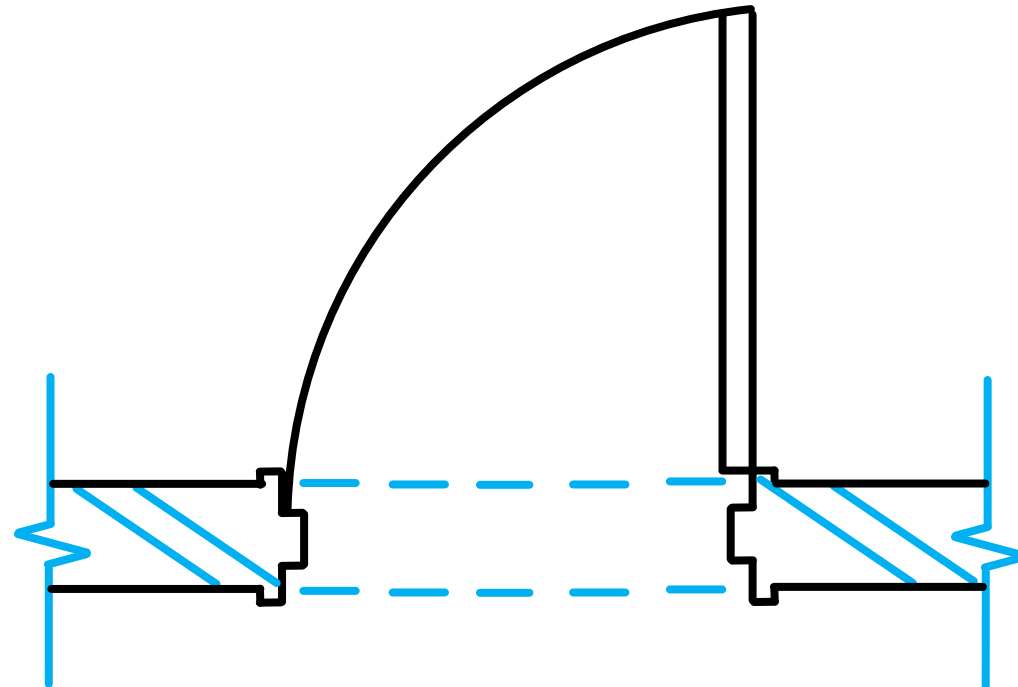

Relevant line types

➔ **B-lines** include

➔ Short broken-lines (B-type) of ± 4 mm lines and ± 4 mm gaps.



Relevant line types

➤ **B-lines** include

➤ Long broken-lines to indicate...

➤ **Contour lines** on civil site plans

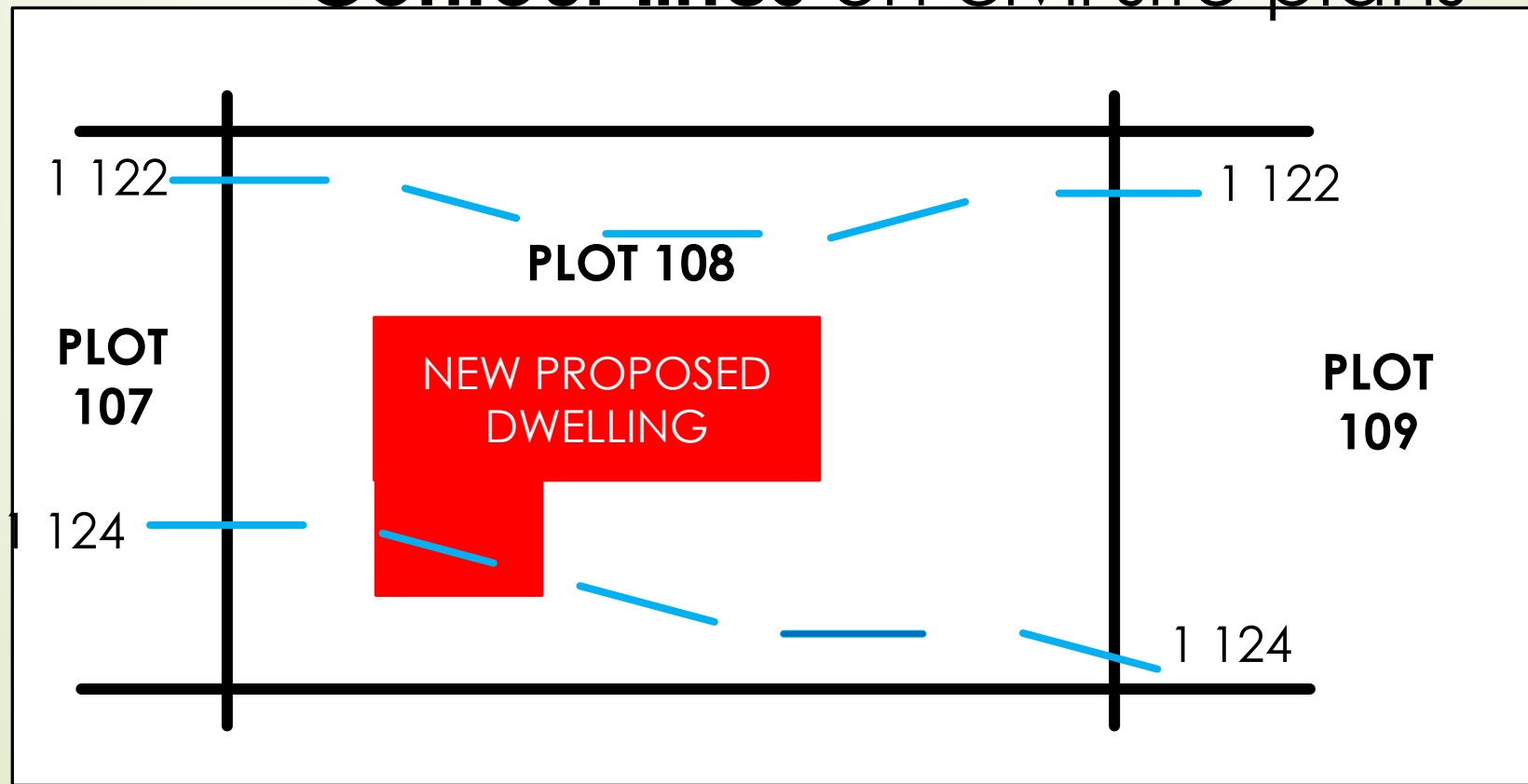

Relevant line types

➔ **B-lines** include

➔ Long broken-lines (B-type) of ± 7 mm lines and ± 7 mm gaps.



Relevant line types

- Drawing **C-lines** with a **pencil** should be **much lighter**, finer and less visible than an A-type of line
- Drawing **C-lines** in black **ink** will be **very thin** lines.
- For **explanation purposes** C-lines in this PowerPoint will be **green**.

Relevant line types

- **C-lines** include
 - **Construction lines**

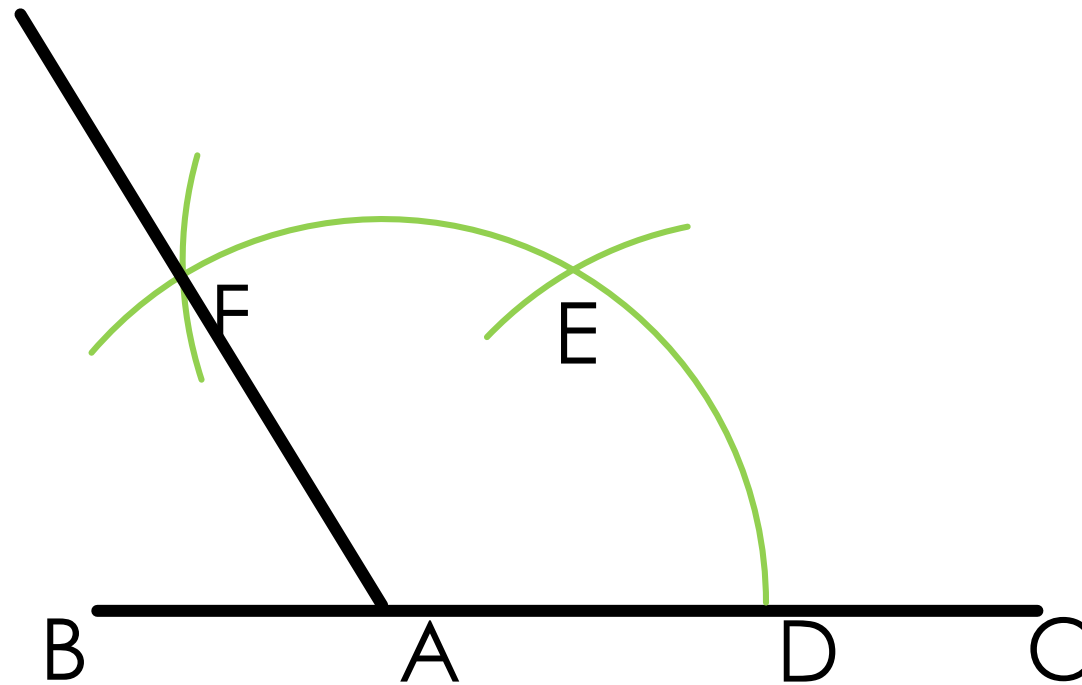

Relevant line types

- **C-lines** include
 - **Projection lines**

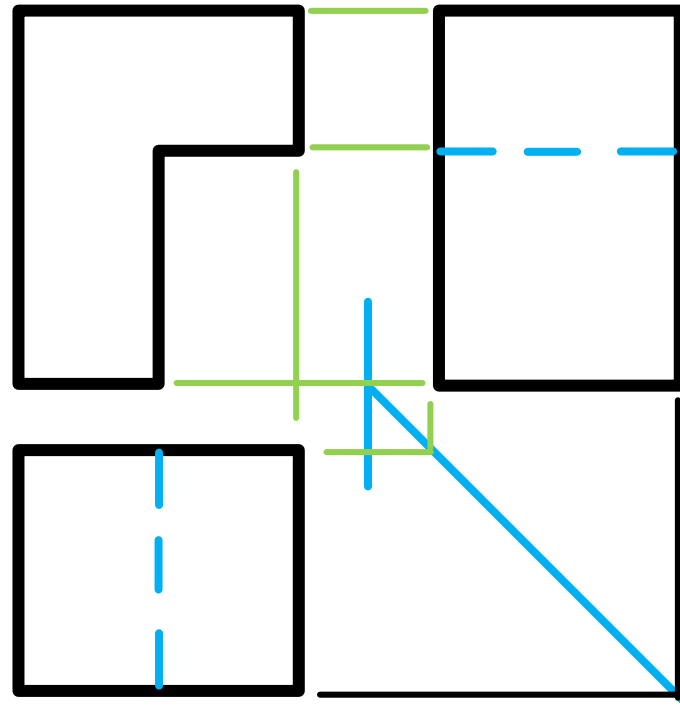

Relevant line types

- **C-lines** include
 - **Guidelines** for lettering .

A B C D E F G H I

J K L M N O P ...

0 1 2 3 4 ...

