

# Principles of Mechanical Drawings – CONSTRUCTION OF A WASHER

Developed by: PC Viljoen  
Senior Educational Specialist for  
Engineering Graphics and Design  
Free State Province

# CONSTRUCTION OF A WASHER

- Hatching of an internal hole.

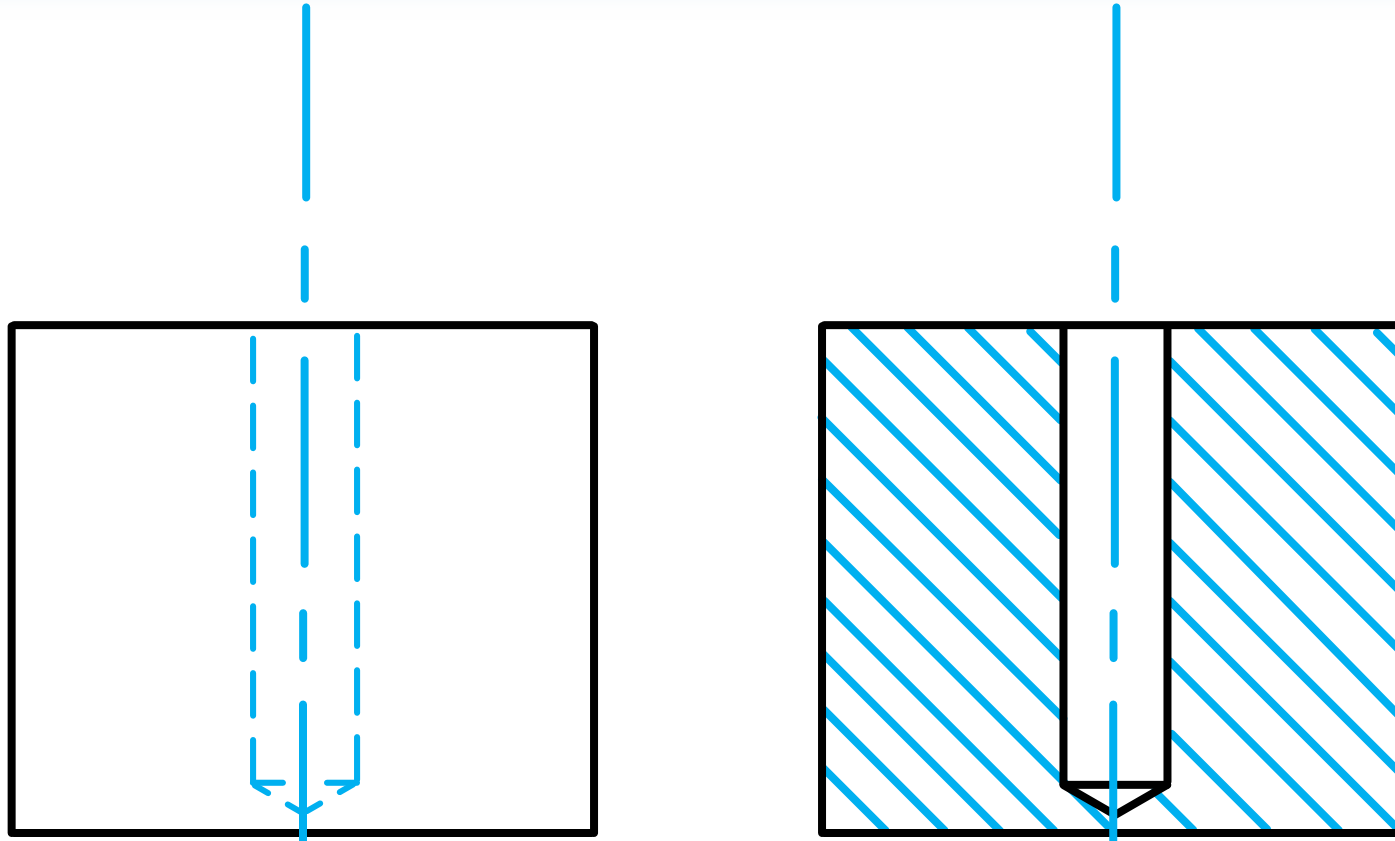

# CONSTRUCTION OF A WASHER

- Hatching of an internal hole with thread.

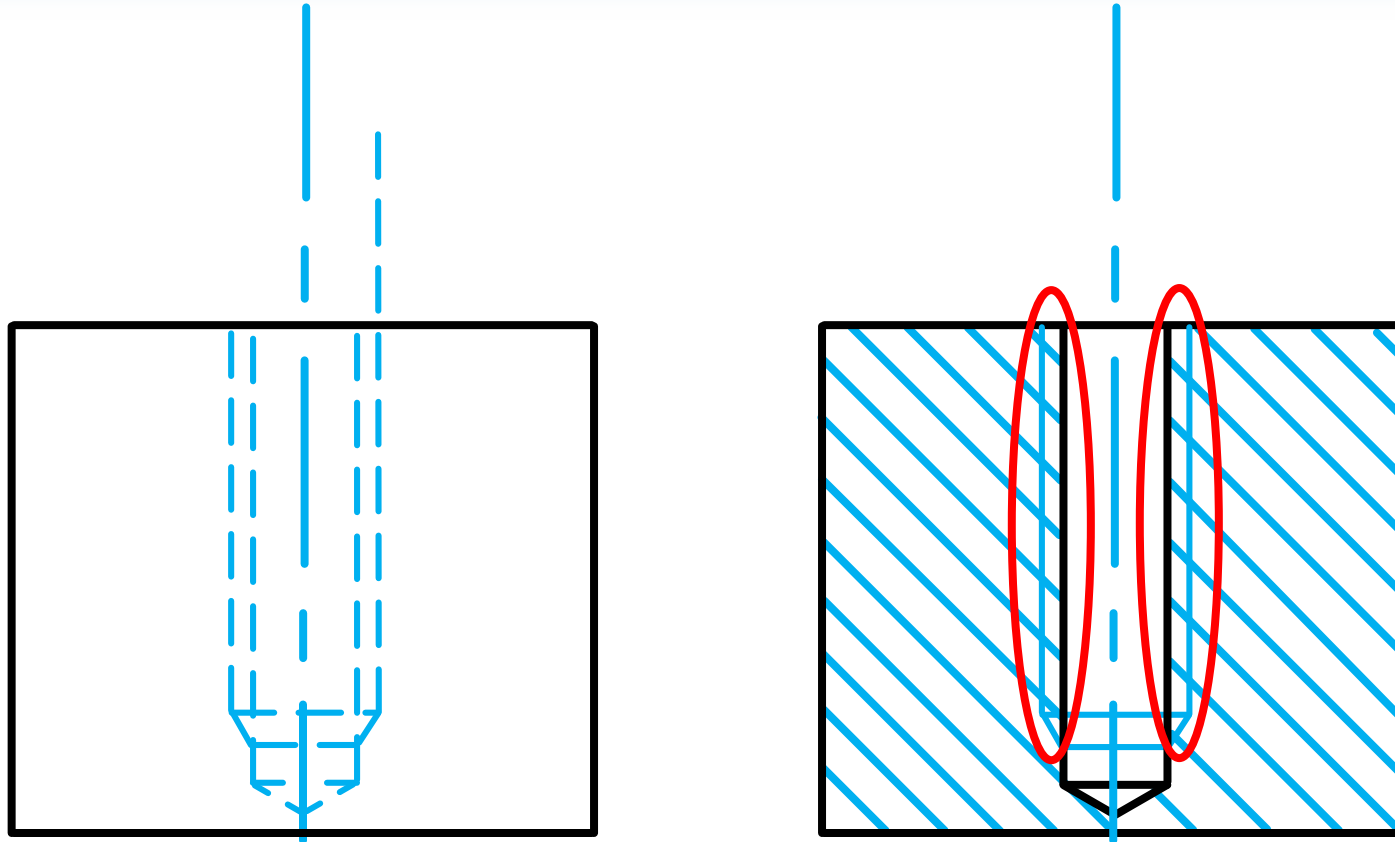

# CONSTRUCTION OF A WASHER

- **Studs** may **not** be sectioned when the cutting plane passes longitudinally through them.

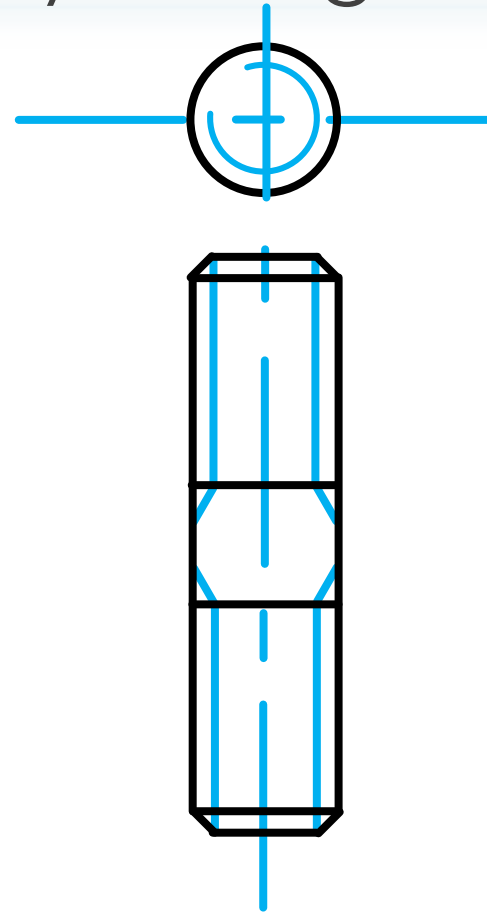

# CONSTRUCTION OF A WASHER

► The diameter for a Washers is:

► = **M X 2**

► = **18 X 2**

► = **36**

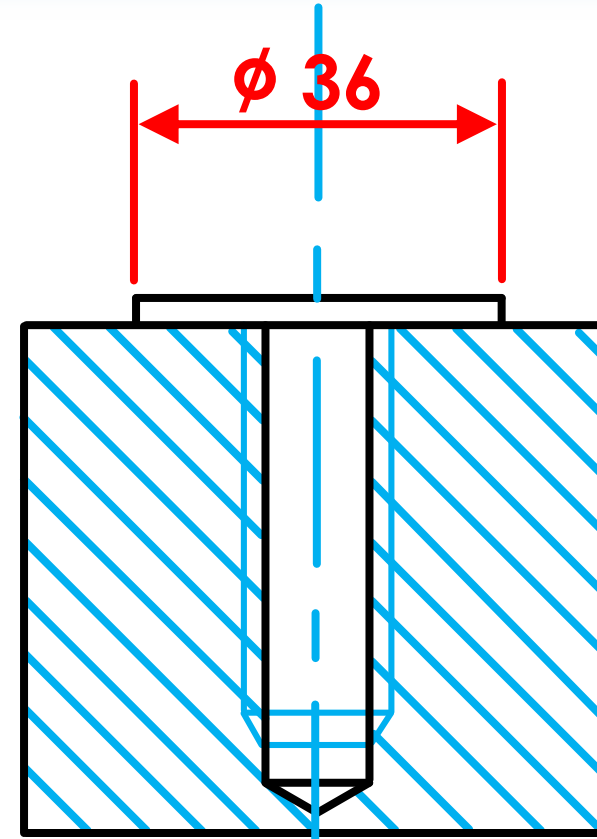

# CONSTRUCTION OF A WASHER

► The thickness for a Washers is:

► =  $M \times 0,2$

► =  $18 \times 0,2$

► =  $3,6$

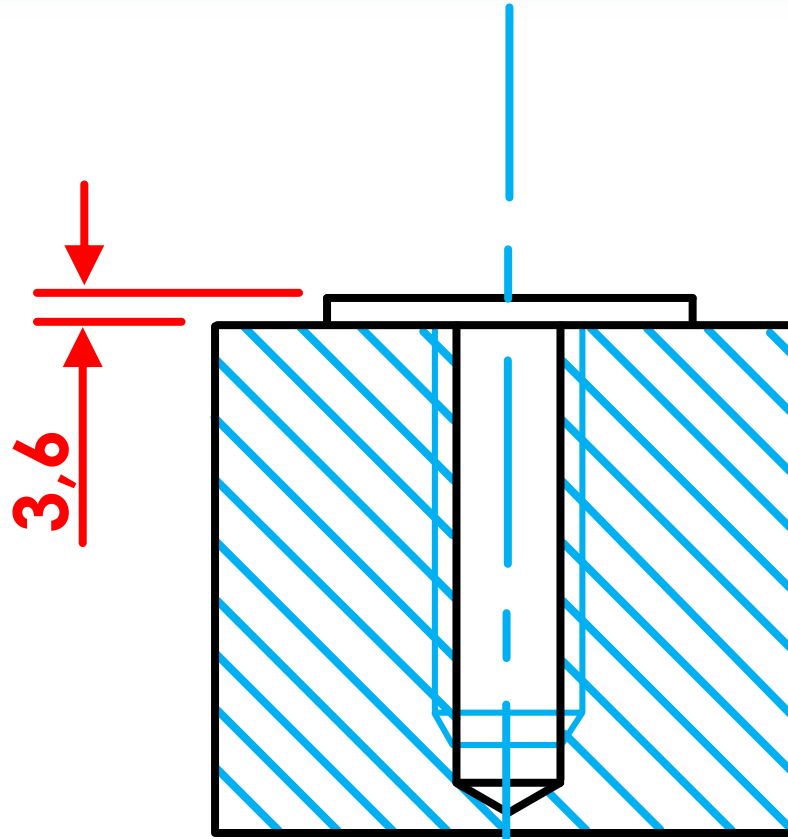

# CONSTRUCTION OF A WASHER

- **Washers** may **not** be sectioned when the cutting plane passes longitudinally through them.

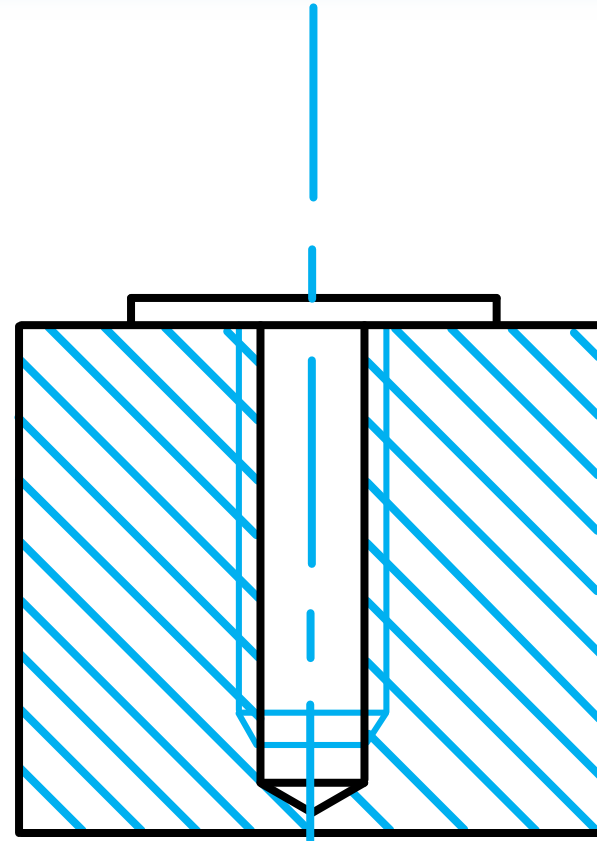

# CONSTRUCTION OF A WASHER

- A washer is placed between the surface of material and the nut.

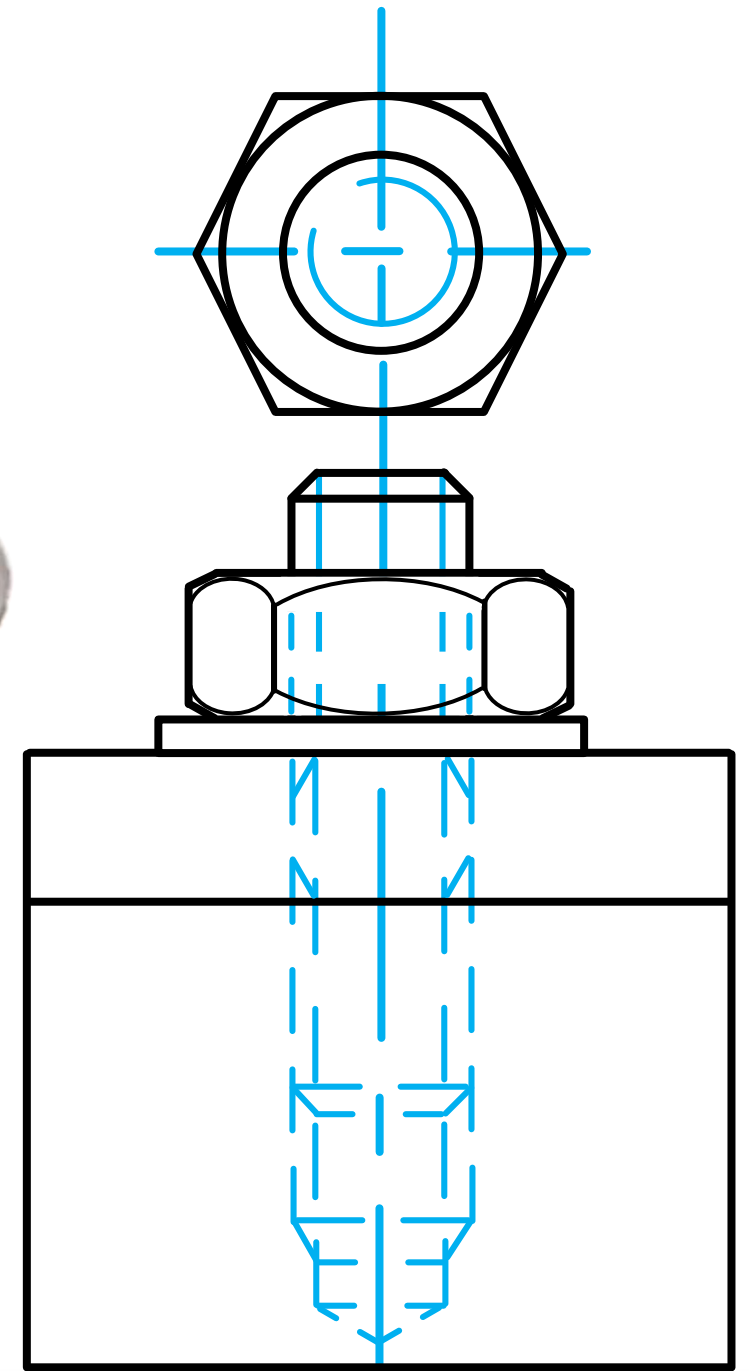

# CONSTRUCTION OF A WASHER

- One of the purposes of a washer is to prevent damage to the surface of the machine part.

