



LOCI of a CAM

Grade 11 & 12

Developed by: PC Viljoen
Senior Educational Specialist for
Engineering Graphics and Design
Free State Province

Loci of a CAM: General information

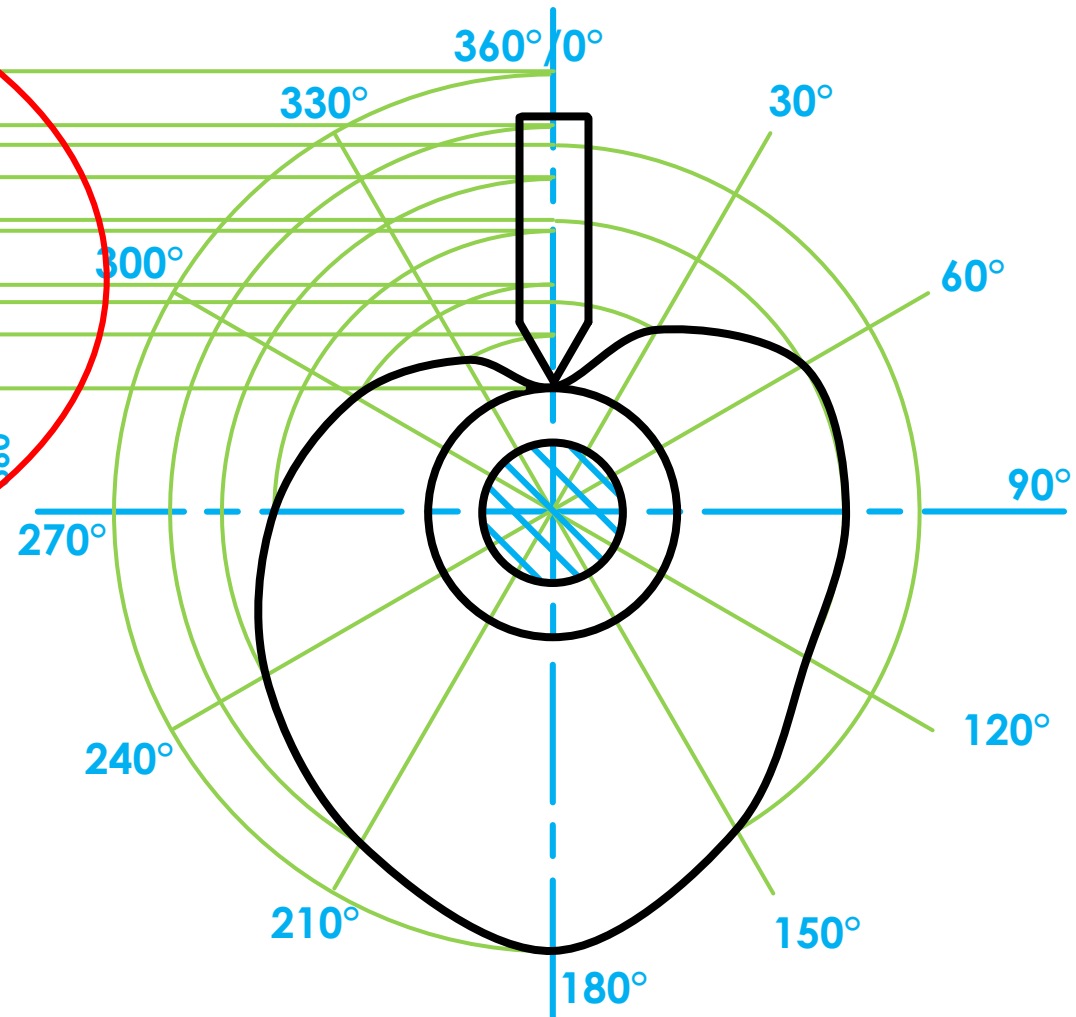
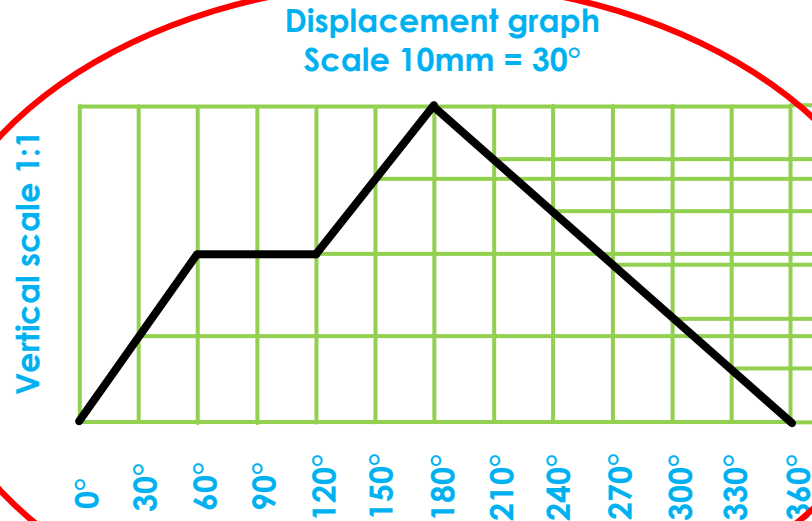

Loci of a CAM: General information

- What is a displacement graph?
 - A displacement graph indicate the different motions of a cam during each stage
 - The vertical scale indicates the max height to which the follower can rise

Loci of a CAM: General information

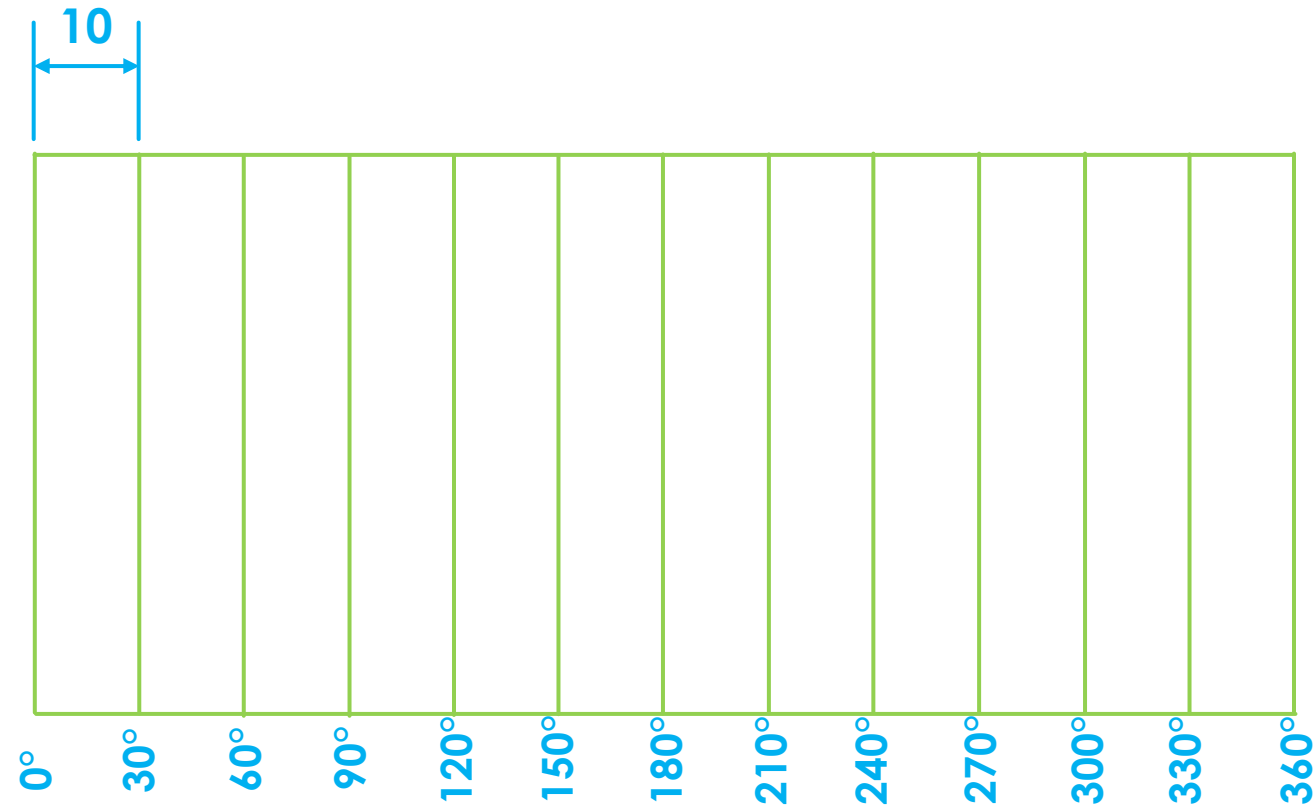

Displacement graph
Scale 10mm = 30°

Vertical scale 1:1
Maximum height
= 60mm

Loci of a CAM: General information

- What is a displacement graph?
 - The displacement graph indicate one rotation of 360° of the cam shaft and cam plate
 - Normally there will be 12 stages, depending of the accuracy of the follower
 - The stages are normally divided into degrees
 - The displacement graph will therefor represent 360° to indicate 12 different stages

Loci of a CAM: General information

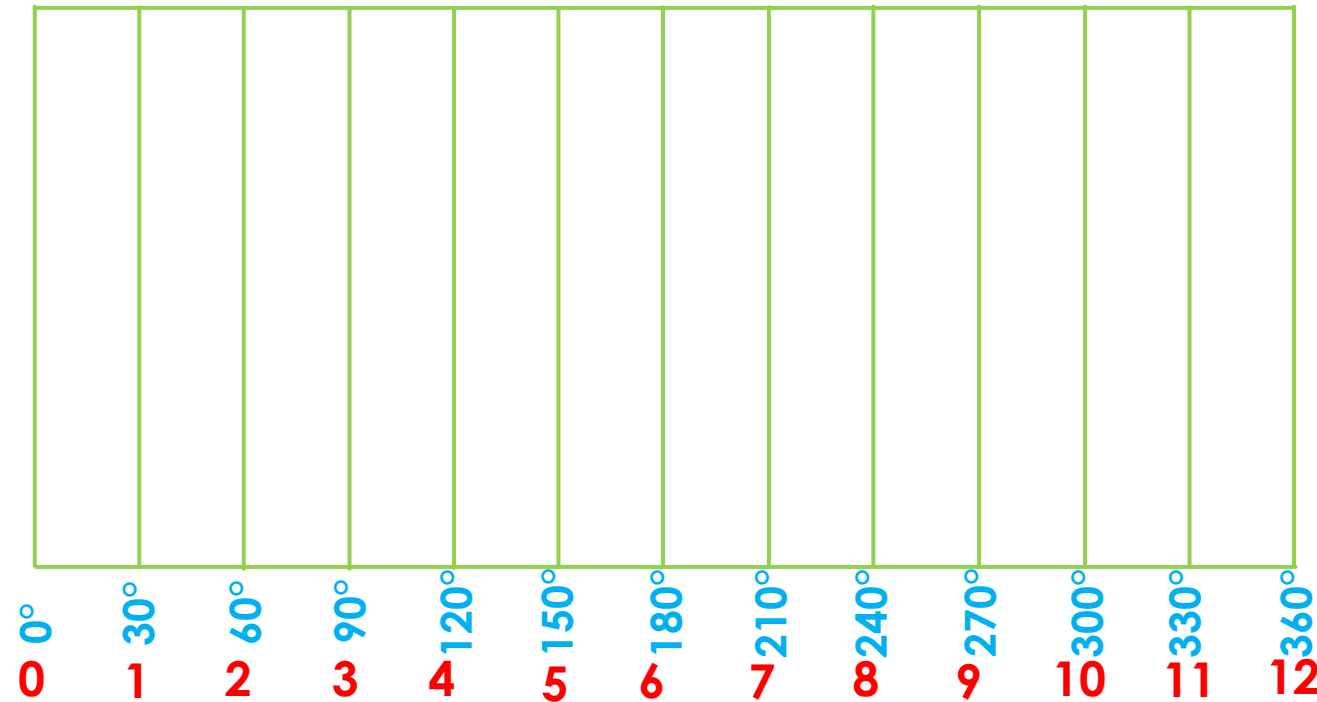

Displacement graph
Scale 10mm = 30°

Vertical scale 1:1
Maximum height
= 60mm

Loci of a CAM

By means of uniform motion

- 0° - 60° : Rise for 50%
- 60° - 120° : Rest
- 120° - 180° : Rise to maximum 60mm
- 180° - 360° : Back to original position

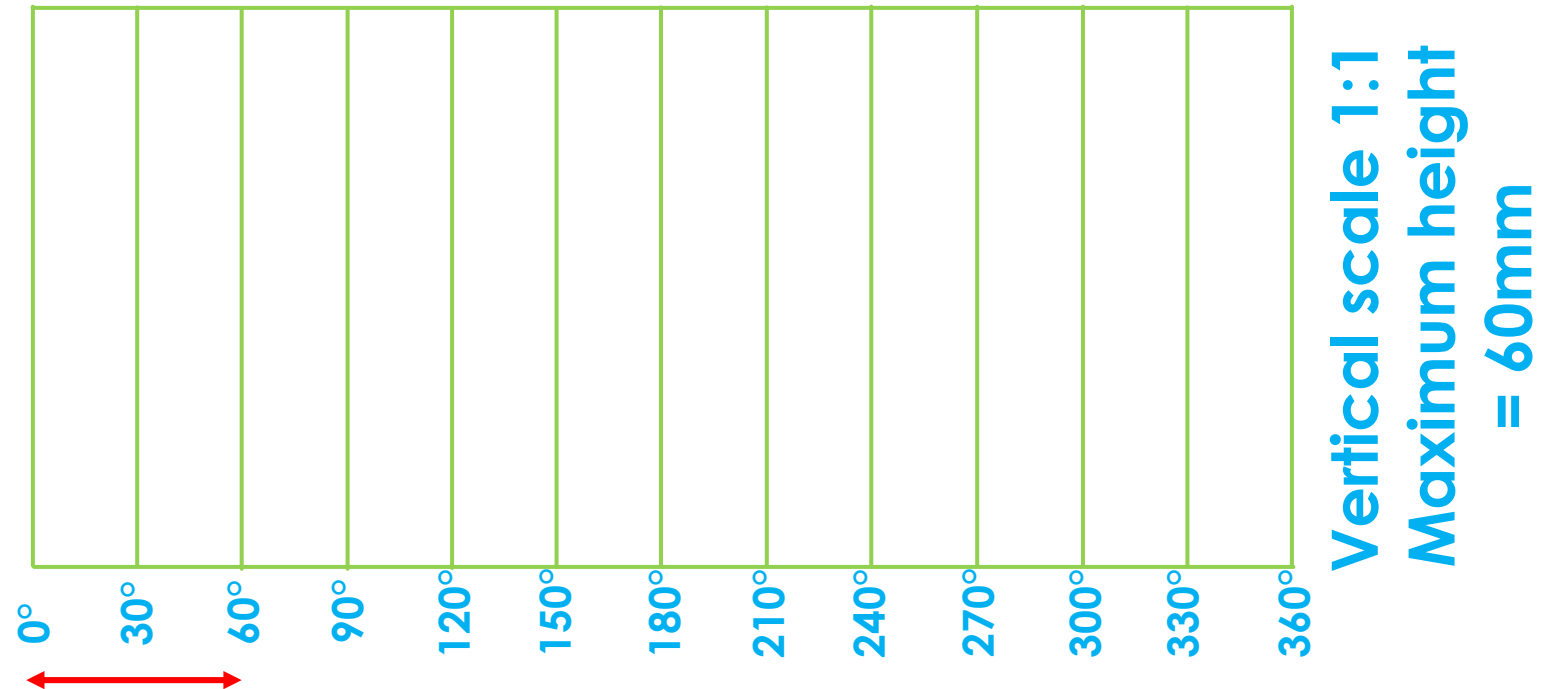

Displacement graph
Scale 10mm = 30°

Loci of a CAM

By means of uniform motion

- 0° - 60° : Rise for 50%
- 60° - 120° : Rest
- 120° - 180° : Rise to maximum 60mm
- 180° - 360° : Back to original position

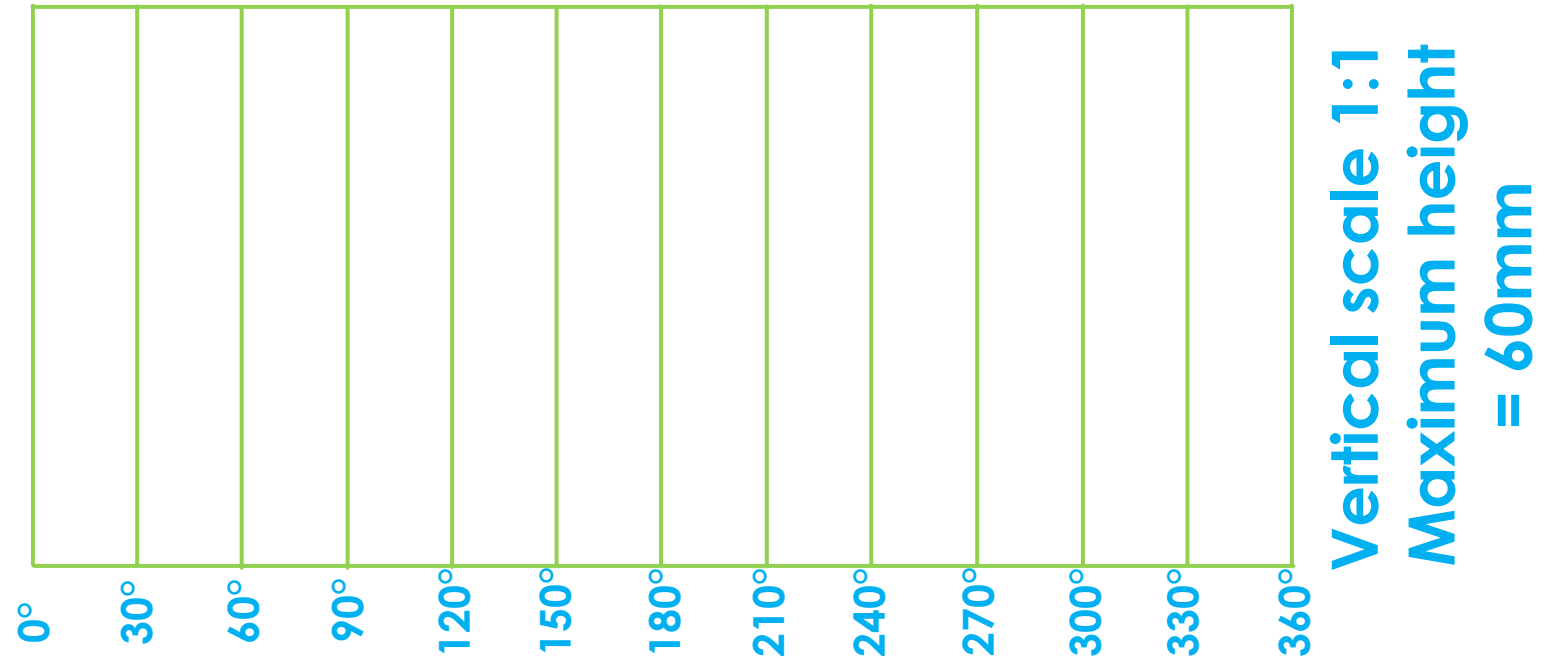

Displacement graph
Scale 10mm = 30°

Loci of a CAM

By means of uniform motion

- 0° - 60° : Rise for 50%
- 60° - 120° : Rest
- 120° - 180° : Rise to maximum 60mm
- 180° - 360° : Back to original position

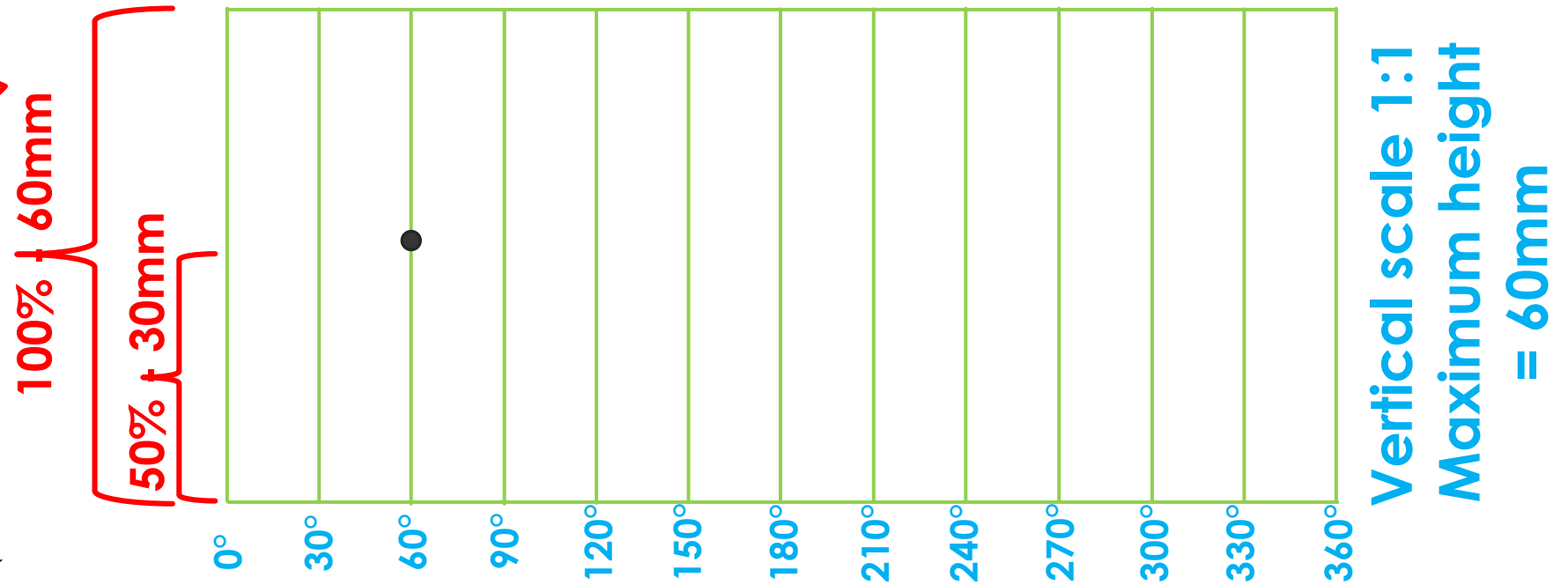

Displacement graph
Scale 10mm = 30°

Loci of a CAM

By means of uniform motion

- 0° - 60° : Rise for 50%
- 60° - 120° : Rest
- 120° - 180° : Rise to maximum 60mm
- 180° - 360° : Back to original position

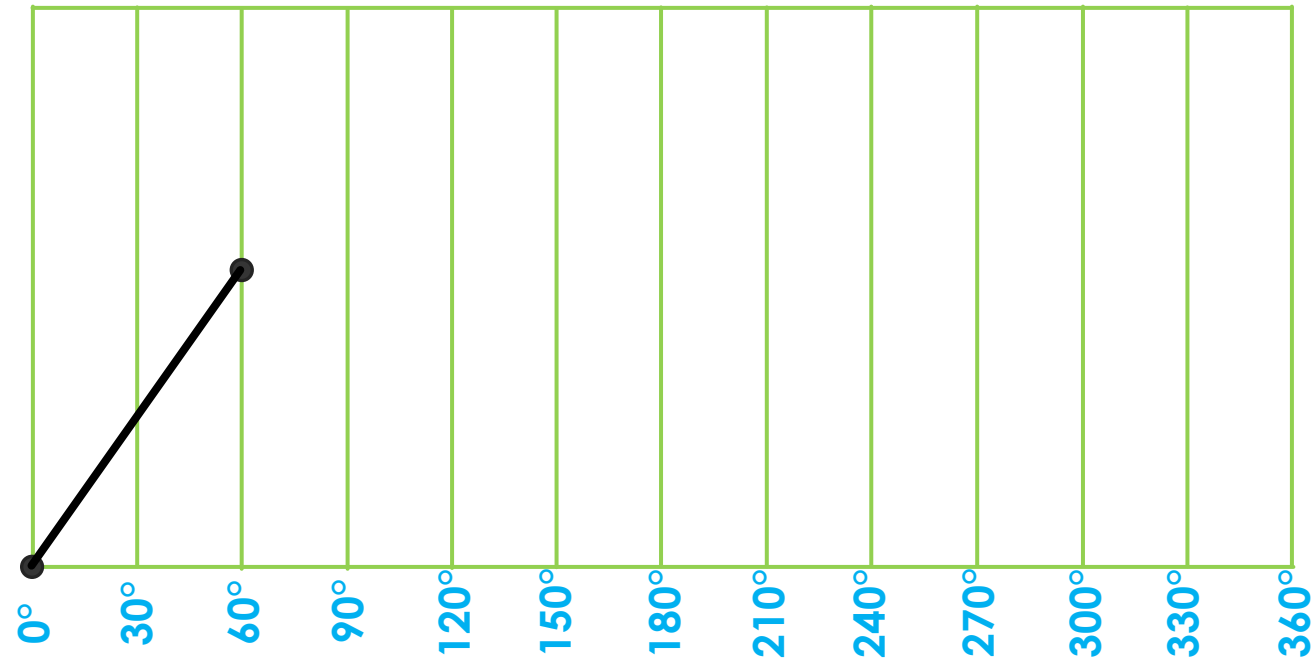

Displacement graph
Scale 10mm = 30°

Vertical scale 1:1

Loci of a CAM

By means of uniform motion

- 0° - 60° : Rise for 50%
- 60° - 120° : Rest
- 120° - 180° : Rise to maximum 60mm
- 180° - 360° : Back to original position

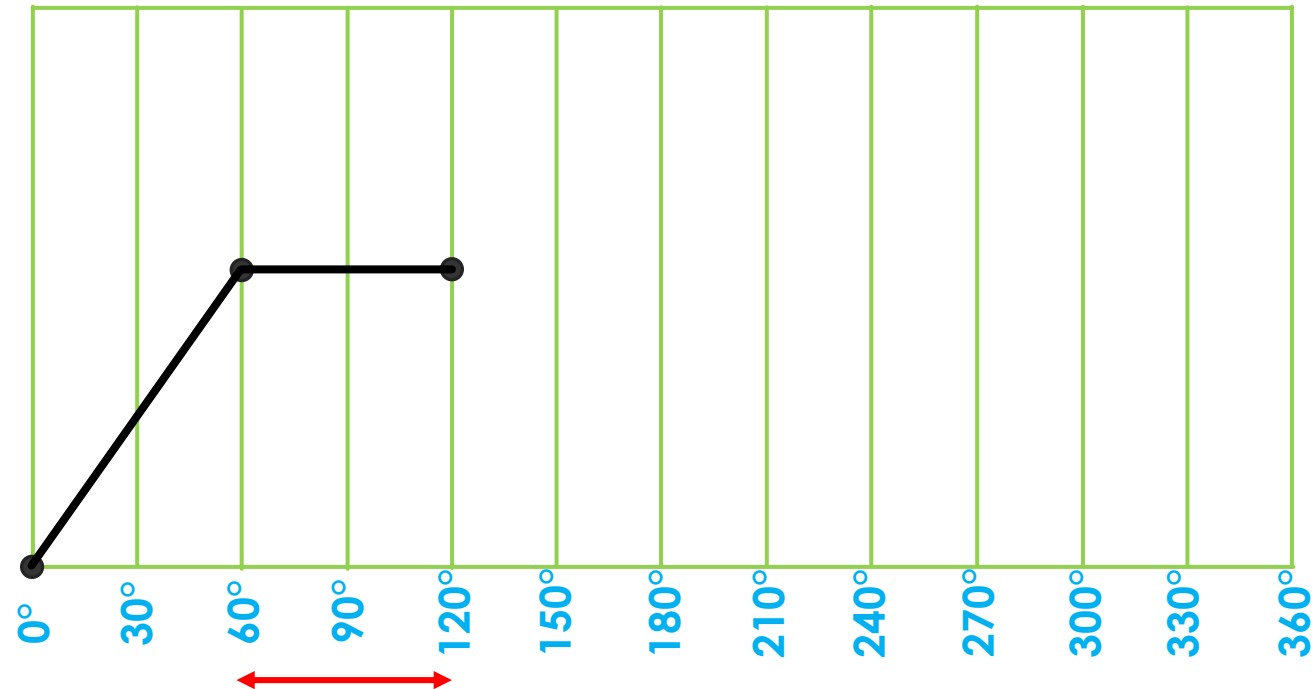

Displacement graph
Scale 10mm = 30°

Vertical scale 1:1

Loci of a CAM

By means of uniform motion

- 0° - 60° : Rise for 50%
- 60° - 120° : Rest
- 120° - 180° : Rise to maximum 60mm
- 180° - 360° : Back to original position

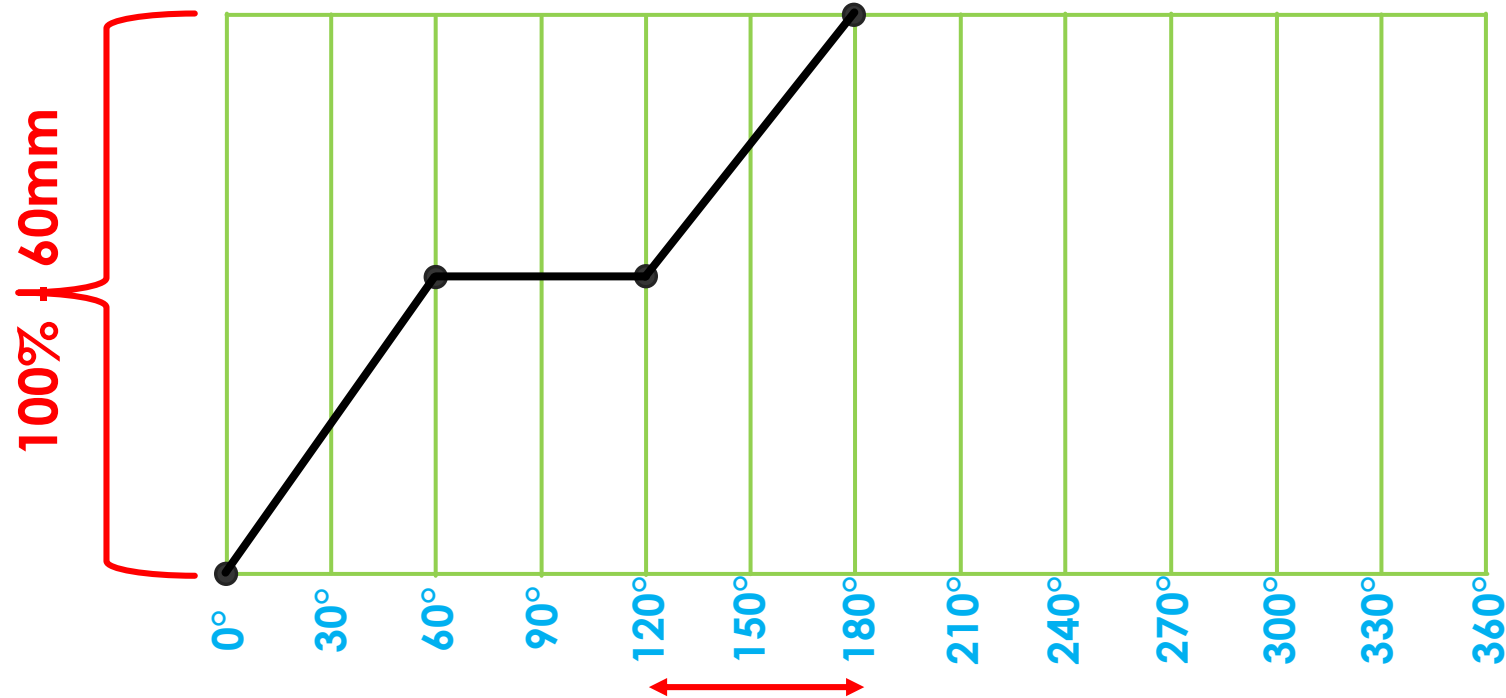

Displacement graph
Scale 10mm = 30°

Loci of a CAM

By means of uniform motion

- 0° - 60° : Rise for 50%
- 60° - 120° : Rest
- 120° - 180° : Rise to maximum 60mm
- 180° - 360° : Back to original position

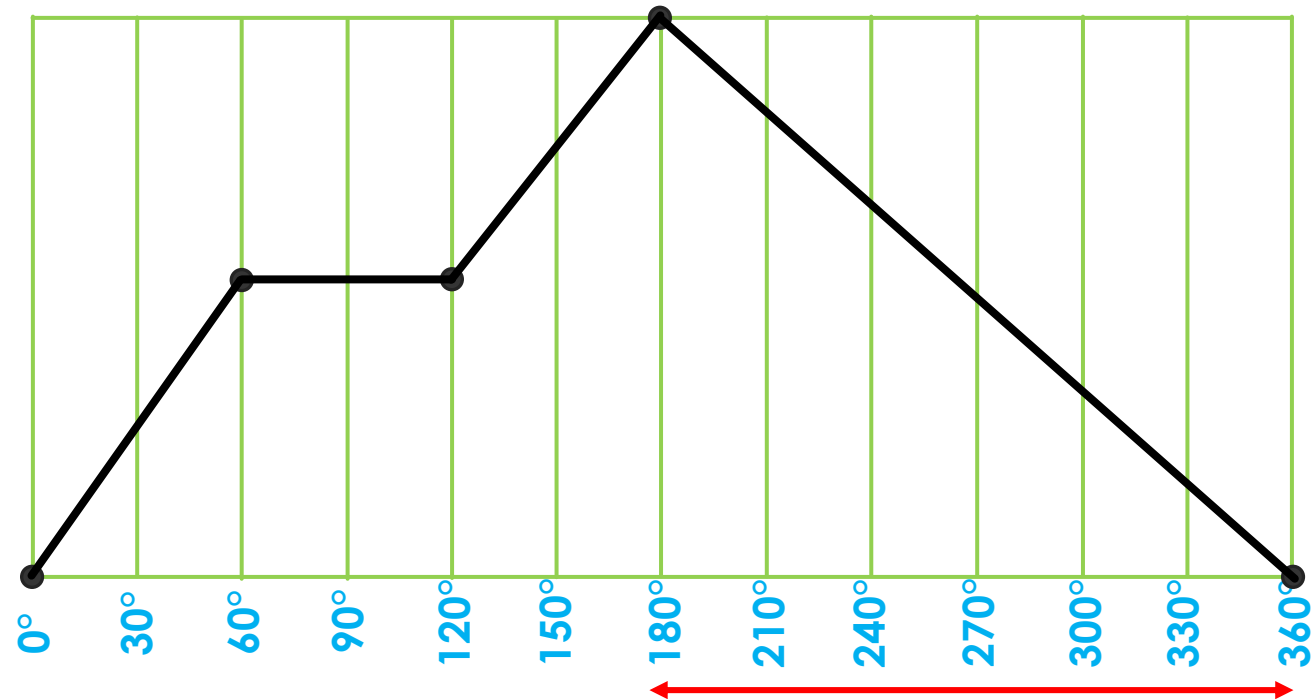

Displacement graph
Scale 10mm = 30°

Vertical scale 1:1

Loci of a CAM

By means of uniform motion

- 0° - 60° : Rise for 50%
- 60° - 120° : Rest
- 120° - 180° : Rise to maximum 60mm
- 180° - 360° : Back to original position

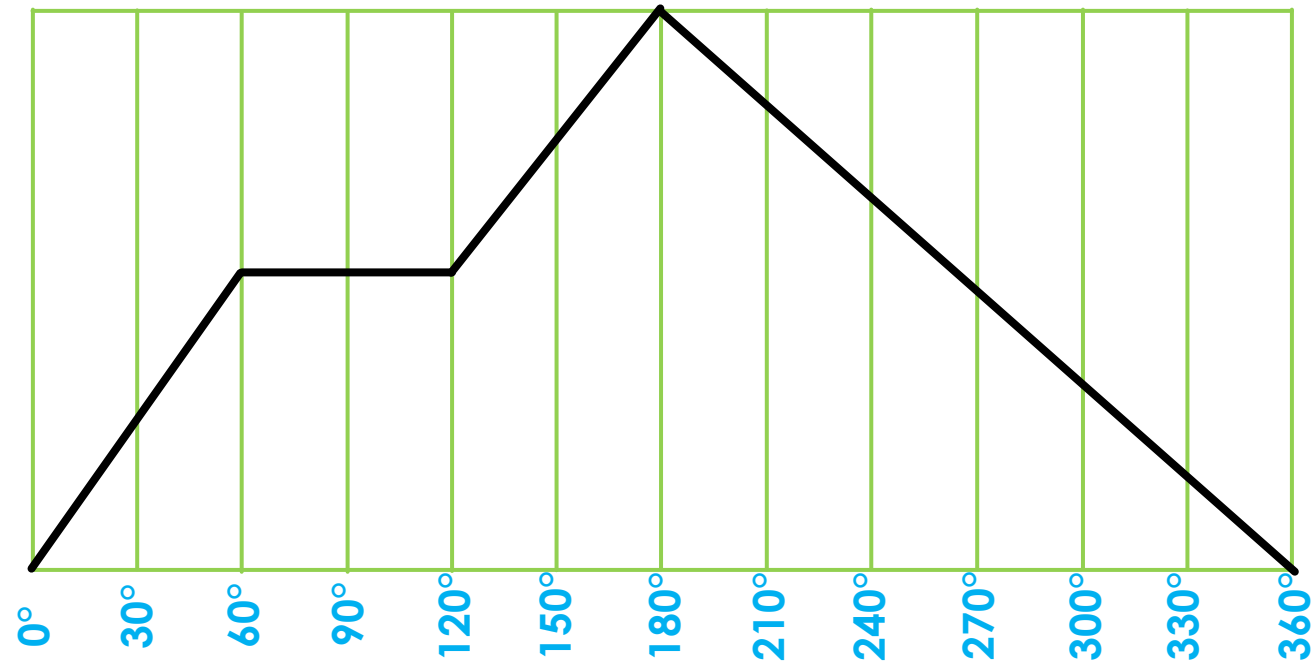

Vertical scale 1:1

Displacement graph
Scale 10mm = 30°

Loci of a CAM

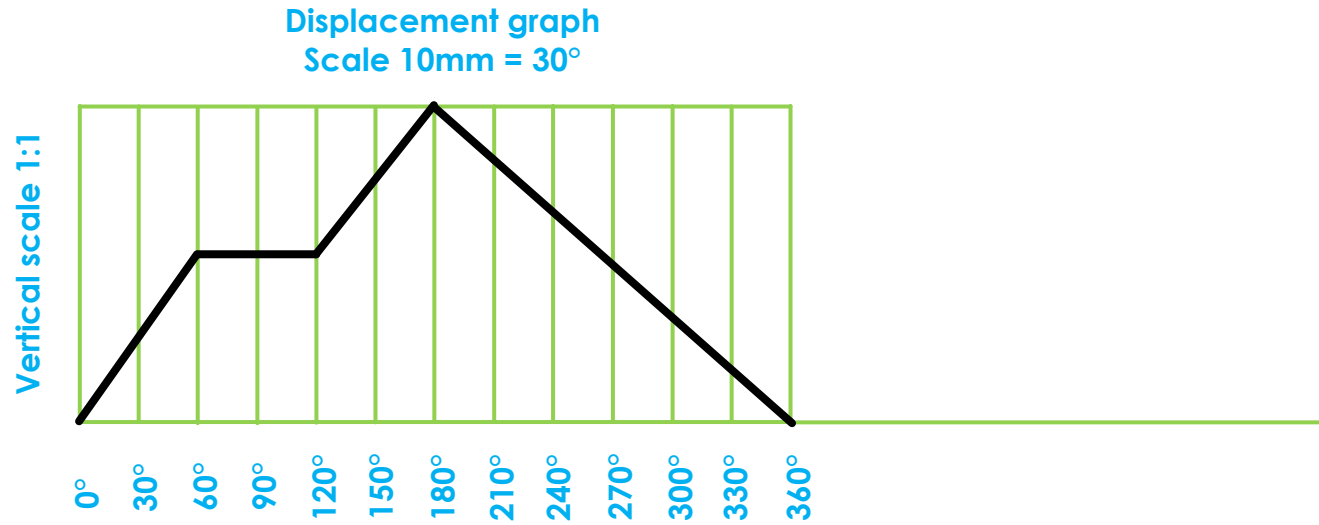

Loci of a CAM: General information

- There might be smaller increments (normally 15°) if more stages are required

Loci of a CAM: General information

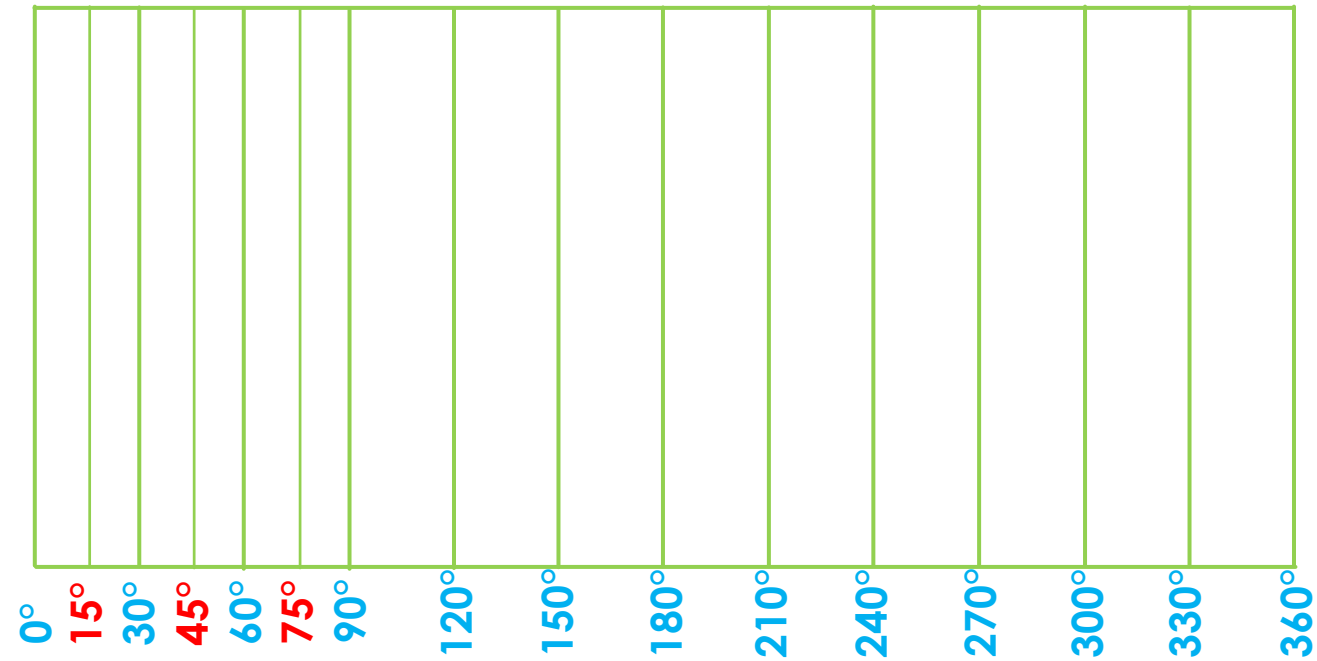

Vertical scale 1:1

Displacement graph
Scale 10mm = 30°

Loci of a CAM: UNIFORM MOVEMENT

By means of uniform motion

- 0° - 45° : Rise with 50mm
- 45° - 135° : Rise to maximum of 70mm
- 135° - 270° : Rest
- 270° - 360° : Back to original position

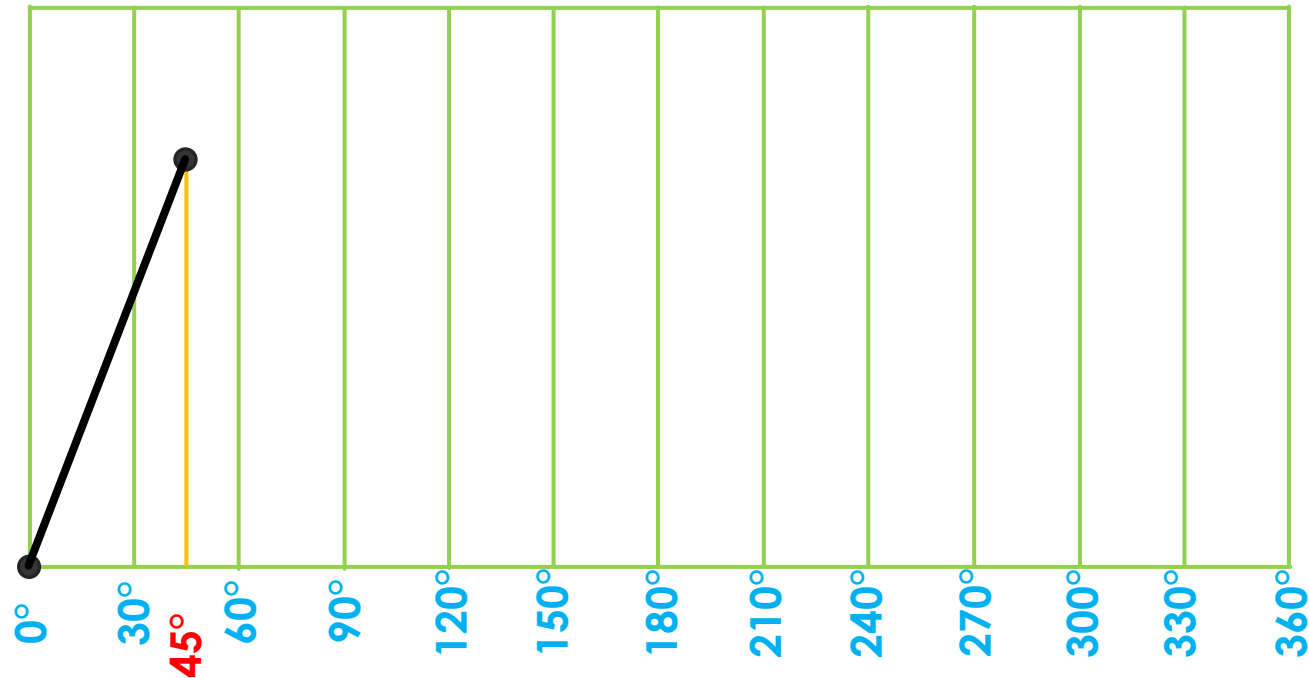

Displacement graph
Scale 10mm = 30°

Vertical scale 1:1

Loci of a CAM: UNIFORM MOVEMENT

By means of uniform motion

- 0° - 45° : Rise with 50mm
- 45° - 135° : Rise to maximum of 70mm
- 135° - 270° : Rest
- 270° - 360° : Back to original position

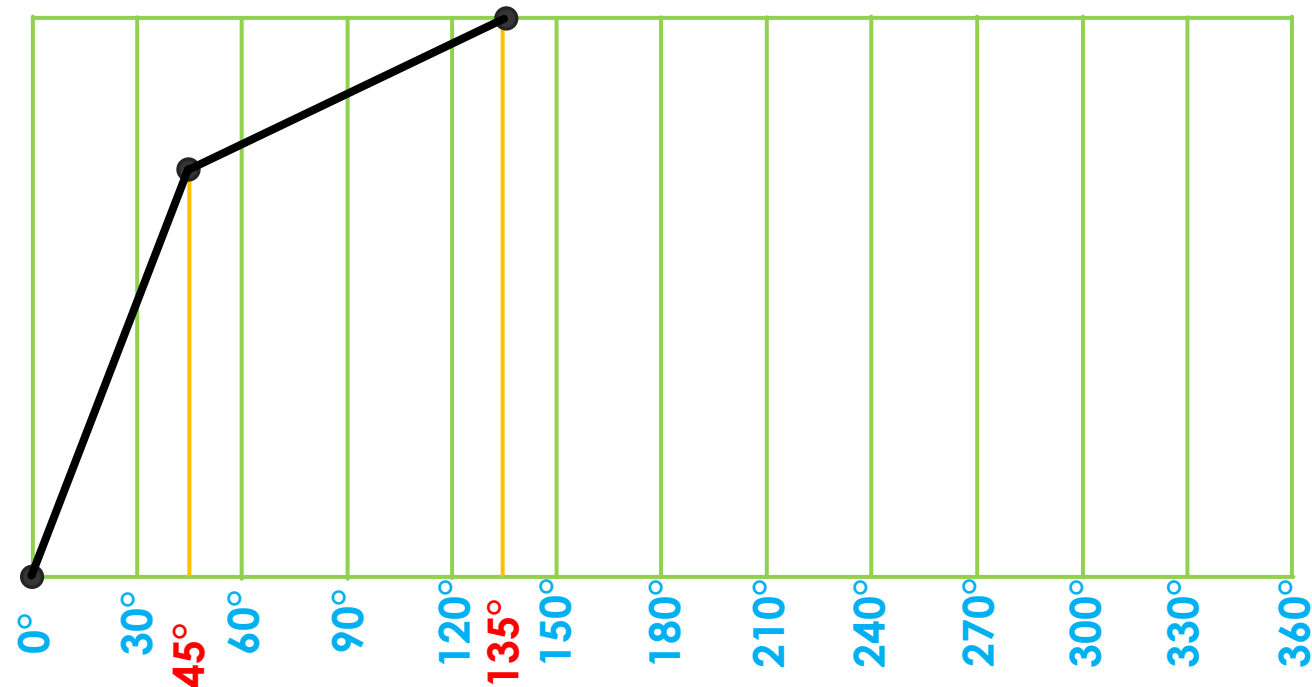

Displacement graph
Scale 10mm = 30°

Vertical scale 1:1

Loci of a CAM: UNIFORM MOVEMENT

By means of uniform motion

- 0° - 45° : Rise with 50mm
- 45° - 135° : Rise to maximum of 70mm
- 135° - 270° : Rest
- 270° - 360° : Back to original position

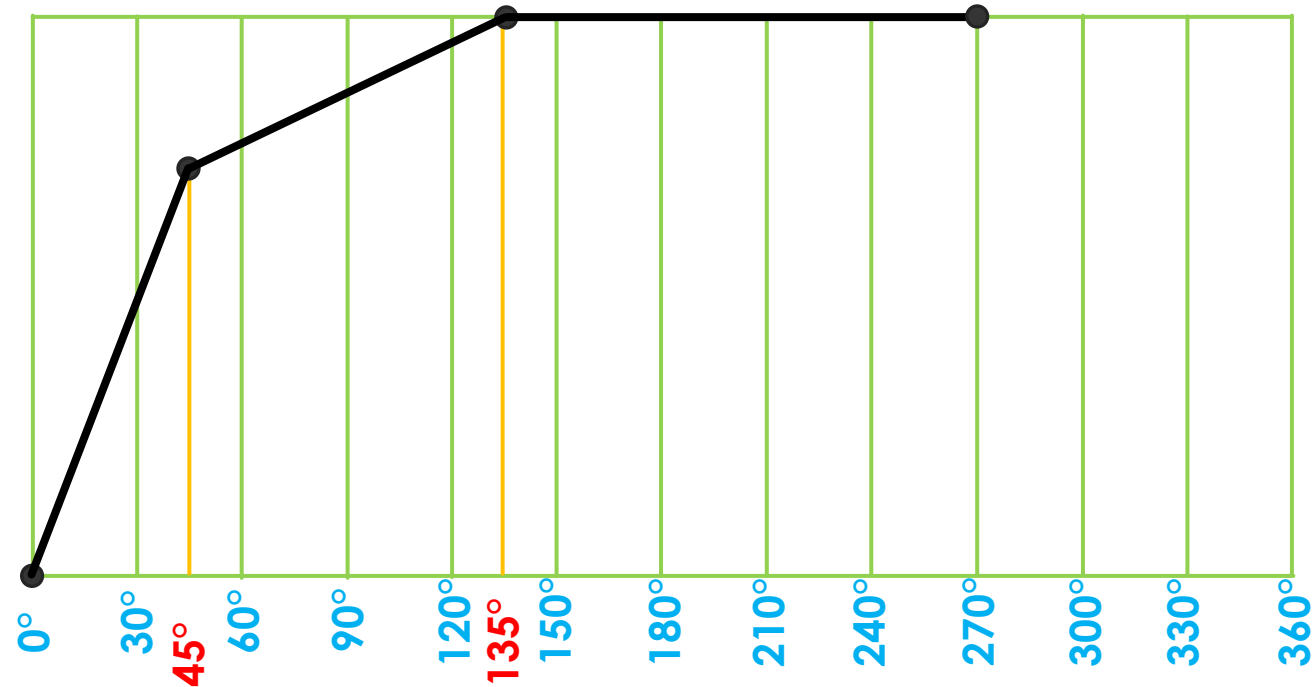

Displacement graph
Scale 10mm = 30°

Vertical scale 1:1

Loci of a CAM: UNIFORM MOVEMENT

By means of uniform motion

- 0° - 45° : Rise with 50mm
- 45° - 135° : Rise to maximum of 70mm
- 135° - 270° : Rest
- 270° - 360° : Back to original position

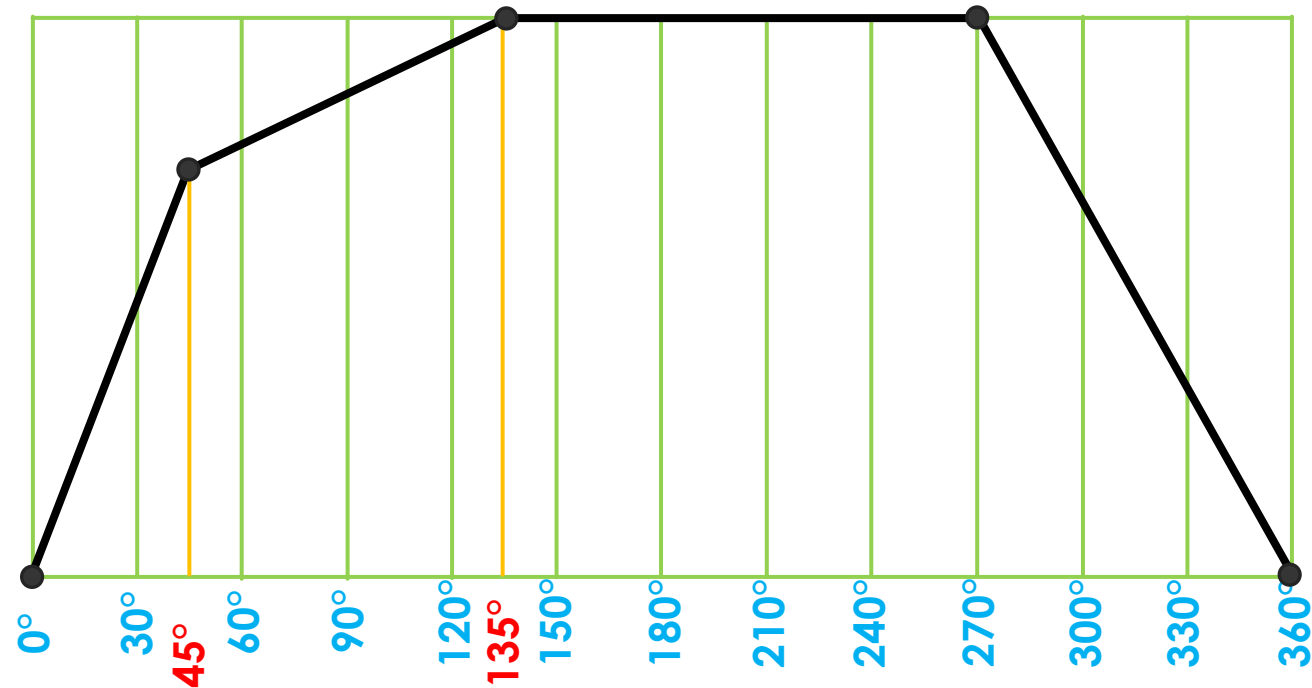

Displacement graph
Scale 10mm = 30°

Vertical scale 1:1